

SMART Board® 800iX3

interactive whiteboard systems

CONFIGURATION AND USER'S GUIDE

FOR MODELS 880iX3 AND 885iX3

FCC warning

This equipment has been tested and found to comply with the limits for a Class A digital device, pursuant to Part 15 of the FCC Rules. These limits are designed to provide reasonable protection against harmful interference when the equipment is operated in a commercial environment. This equipment generates, uses and can radiate radio frequency energy and, if not installed and used in accordance with the manufacturer's instructions, may cause harmful interference to radio communications. Operation of this equipment in a residential area is likely to cause harmful interference in which case the user will be required to correct the interference at his own expense.

Trademark notice

SMART Board, SMART GoWire, SMART Meeting Pro, DVIT, smarttech, the SMART logo and all SMART taglines are trademarks or registered trademarks of SMART Technologies ULC in the U.S. and/or other countries. Texas Instruments, BrilliantColor, DLP, and DLP Link are trademarks of Texas Instruments. Microsoft, Windows and Internet Explorer are either registered trademarks or trademarks of Microsoft Corporation in the U.S. and/or other countries. Blu-ray is a trademark of Blu-ray Disc Association. All other third-party product and company names may be trademarks of their respective owners.

Copyright notice

© 2015 SMART Technologies ULC. All rights reserved. No part of this publication may be reproduced, transmitted, transcribed, stored in a retrieval system or translated into any language in any form by any means without the prior written consent of SMART Technologies ULC. Information in this manual is subject to change without notice and does not represent a commitment on the part of SMART.

This product and/or use thereof covered by one or more of the following U.S. patents: smarttech.com/patents.

05/2015

Important information

Before you install and use the SMART Board® interactive whiteboard system, read and understand the safety warnings and precautions in this user's guide and the included important information document. These safety warnings and precautions describe the safe and correct operation of the interactive whiteboard system and its accessories, helping you prevent injuries and equipment damage. Ensure that the interactive whiteboard system is always used correctly.

In this document, “interactive whiteboard system” refers to the following:

- SMART Board 800 series interactive whiteboard
- SMART U100 or SMART U100w projector
- Accessories and optional equipment

The projector included with the system is designed to work only with certain SMART Board interactive whiteboard models. Contact your authorized SMART reseller (smarttech.com/where) for more information.

Safety warnings, cautions and important information

Installation



WARNING

- Failure to follow the installation instructions shipped with the SMART product could result in injury and damage to the product.
- To reduce the risk of fire or electric shock, do not expose the SMART product to rain or moisture.
- Two people are required to mount your SMART product because it may be too heavy for one person to safely maneuver.

When you lift the interactive whiteboard, you and your assistant should stand on either side of the screen, supporting its weight at the bottom while balancing the top with your other hand.

IMPORTANT INFORMATION

- When mounting the projector boom on a framed or hollow wall, attach the mounting bracket to a stud to safely support the projector's weight. If you use only drywall anchors, the drywall can fail, resulting in possible injury and damage to the product which may not be covered by the warranty.
- Do not leave cables on the floor where they can be a tripping hazard. If you must run a cable over the floor, lay it in a flat, straight line and secure it to the floor with tape or a cable management strip of a contrasting color. Handle cables carefully and avoid excessive bending.

CAUTION

- Do not operate this unit immediately after moving it from a cold location to a warm location. When the unit is exposed to such a change in temperature, moisture can condense on the lens and crucial internal parts. Allow the system to reach room temperature before operation to prevent possible damage to the unit.
- Do not place the unit in hot locations, such as near heating equipment. Doing so could cause a malfunction and shorten the life of the projector.
- Avoid setting up and using the SMART product in an area with excessive levels of dust, humidity and smoke.
- Do not place your SMART product in direct sunlight or near any appliance that generates a strong magnetic field.
- If you need to lean the interactive whiteboard against a wall before you mount it, make sure it remains in an upright position, resting on the pen tray brackets, which can sustain the weight of the interactive whiteboard.

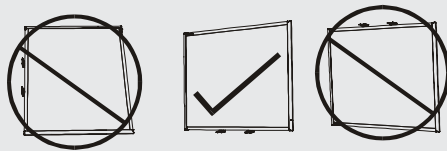

Do not rest the interactive whiteboard on its side or on the top of the frame.

- You must connect the USB cable that came with your SMART Board interactive whiteboard to a computer that has a USB compliant interface and that bears the USB logo. In addition, the USB source computer must be compliant with CSA/UL/EN 60950 and bear the CE mark and CSA and/or UL Mark(s) for CSA/UL 60950. This is for operating safety and to avoid damage to the SMART Board interactive whiteboard.

IMPORTANT INFORMATION



IMPORTANT

- Use the *SMART Board 800ix3 interactive whiteboard system installation guide* (smarttech.com/kb/170885) to install the interactive whiteboard and projector.
- Make sure an electrical socket is near the SMART product and remains easily accessible during use.
- Using the SMART product near a TV or radio could cause interference to the images or sound. If this happens, move the TV or radio away from the projector.

Operation



WARNING

- If you are using an external audio system, use only the power supply included with that product. Using the wrong power supply might create a safety hazard or damage the equipment. If in doubt, refer to the specification sheet for your product to verify the power supply type.
- Do not climb (or allow children to climb) on a wall- or stand-mounted SMART Board interactive whiteboard.

Do not climb on, hang from or suspend objects from the projector boom.

Climbing on the interactive whiteboard or projector boom could result in injury or product damage.



- Refer to the safety warnings and precautions published by the projector manufacturer. Do not stare (or allow children to stare) directly into the projector's beam of light.
- Do not touch (or allow children to touch) your projector because it can become extremely hot during normal operation.
- Do not stand (or allow children to stand) on a chair to touch the surface of the SMART Board product. Instead, safely fix the product at the appropriate height on a wall or use a SMART height-adjustable floor stand.
- To prevent injury or product and property damage, use only the mounting hardware supplied with the SMART Board 800 series interactive whiteboard when you install the product on drywall. The mounting hardware provided with other interactive whiteboards may not be strong enough to support the weight of SMART Board 800 series interactive whiteboards.

IMPORTANT INFORMATION

CAUTION

- Do not block the projector's ventilation slots and openings.
- If dust or small items prevent pen tray buttons from being pressed or cause constant button contact, remove the obstructions carefully.

IMPORTANT

- Keep the remote control in a safe place because there is no other way to access menu options.
- Do not disconnect cables from the ECP to connect peripheral devices because you could disconnect controls for your interactive whiteboard.
- Disconnect the product from its power source when it's not used for a long period.

Other precautions

If you're using a SMART product other than a SMART Board interactive whiteboard system, refer to the product's installation manual for relevant warnings and maintenance instructions.

Environmental requirements

Before you install the SMART Board interactive whiteboard system, review the following environmental requirements.

Environmental requirement	Parameter
Operating temperature	<ul style="list-style-type: none">• 41°F to 95°F (5°C to 35°C) from 0' to 6000' (0 m to 1800 m)• 41°F to 86°F (5°C to 30°C) from 6000' to 9800' (1800 m to 3000 m)
Operating temperature (projector)	<ul style="list-style-type: none">• Standard speed: 41°F to 95°F (5°C to 35°C) from 0' to 6000' (0 m to 1800 m)• High speed: 41°F to 86°F (5°C to 30°C) from 6000' to 6800' (1800 m to 2100 m)
Storage temperature	-4°F to 122°F (-20°C to 50°C)
Humidity	<ul style="list-style-type: none">• Up to 85% storage relative humidity, non-condensing• Up to 85% operating relative humidity, non-condensing
Water and fluid resistance	<ul style="list-style-type: none">• Intended for indoor use only. Doesn't meet any salt-spray or water ingress requirements.• Don't pour or spray liquids directly onto your interactive whiteboard, the projector or any of its sub-components.

IMPORTANT INFORMATION

Environmental requirement	Parameter
Dust	Intended for use in office and classroom environments. Not for industrial use where heavy dust and pollutants can cause malfunctions or impaired operation. Periodic cleaning is required in areas with heavier dust. See <i>Cleaning the projector</i> on page 32 for information on cleaning the projector.
Electrostatic discharge (ESD)	<ul style="list-style-type: none">• EN61000-4-2 severity level 4 for direct and indirect ESD• No malfunction or damage up to 8kV (both polarities) with a 330 ohm, 150 pF probe (air discharge)• Unmated connectors meet no malfunction or damage up to 4kV (both polarities) for direct (contact) discharge
Cables	All SMART Board interactive whiteboard system cables should be shielded to prevent potential accidents and degraded video and audio quality.
Conducted and radiated emissions	EN55022/CISPR 22, Class A

Contents

Important information	i
Safety warnings, cautions and important information	i
Environmental requirements	iv
Chapter 1: About the interactive whiteboard system	1
SMART Board interactive whiteboard system features	2
Included accessories	4
Optional accessories	5
Chapter 2: Installing the interactive whiteboard system	7
Choosing a location	7
Choosing a height	8
Securing the interactive whiteboard system	9
Routing the cables	9
Installing SMART software	10
Chapter 3: Using the interactive whiteboard system	11
Using the projector	11
Using the interactive whiteboard	27
Using the Extended Control Panel (ECP)	27
Using the optional RCA connector pod	29
Chapter 4: Maintaining the interactive whiteboard system	31
Maintaining the interactive whiteboard	31
Cleaning the projector	32
Focusing and adjusting the projector image	33
Replacing the projector lamp	33
Chapter 5: Troubleshooting the interactive whiteboard system	41
Before you start	42
Determining the interactive whiteboard system's status	44
Resolving interactive whiteboard issues	46
Resolving projector errors	48
Resolving image issues	49
Resolving audio issues	52
Resolving ECP issues	53
Resolving network communication issues	53
Accessing the service menu	54
Transporting the interactive whiteboard system	55

CONTENTS

Appendix A: Remotely managing the system through a network interface 57

 Web page management 57

 Simple Network Management Protocol (SNMP) 65

Appendix B: Remotely managing the system through an RS-232 serial interface 67

 Connecting a room control system to the ECP 68

 Projector programming commands 69

Appendix C: Integrating other devices 95

 Video format 95

 Connecting peripheral sources and outputs 101

Appendix D: Remote control code definitions 103

Appendix E: Hardware environmental compliance 105

 Waste Electrical and Electronic Equipment and Battery regulations (WEEE and
 Battery Directives) 105

 Batteries 105

 Mercury 105

 More information 105

Index 107

Chapter 1

About the interactive whiteboard system

SMART Board interactive whiteboard system features	2
SMART Board 800 series interactive whiteboard	2
SMART U100 or SMART U100w projector	3
Extended Control Panel (ECP)	4
Included accessories	4
Remote control	4
Pens	4
Eraser	5
Optional accessories	5
VGA connection kit	5
RCA connector pod	5

The SMART Board interactive whiteboard system combines the following components:

- SMART Board 800 series interactive whiteboard
- Wall-mounted, short-throw SMART U100 or SMART U100w projector
- Accessories and optional equipment

This chapter describes the features of the interactive whiteboard and provides information about product parts and accessories.

SMART Board interactive whiteboard system features

The SMART Board interactive whiteboard system uses the short-throw, high-offset SMART U100 or SMART U100w projector. When the projector displays an image from your computer on the touch-sensitive interactive whiteboard, you can do everything that you can do at your computer—open and close applications, scroll through files, conference with others, create new documents or edit existing ones, visit websites, play video clips and more—by touching the screen. Two users can also draw on the interactive surface at the same time, and you can use an array of gestures within applications.

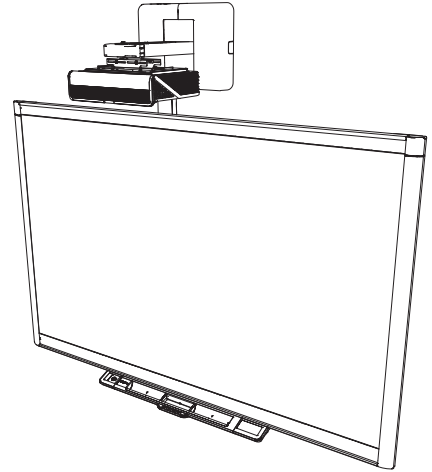

This projector also supports video and audio connections from a variety of devices (including DVD/Blu-ray™ players, VCRs, document cameras and digital cameras) and can project media from these sources onto the interactive screen.

When you use SMART software with your SMART Board interactive whiteboard system, you can write or draw over the projected computer image in digital ink using a pen tray pen or your finger, and then save these notes to a .notebook file or directly into any Ink Aware application.

SMART Board 800 series interactive whiteboard

The SMART Board 800 series interactive whiteboard, featuring SMART's proprietary DVIT® (Digital Vision Touch) technology, is the most intuitive touch-sensitive front projection interactive whiteboard in the world.

The SMART Board 800 series interactive whiteboard performs best with the SMART U100 or U100w projector because of its exceptional color performance, aspect ratio, input response and short-throw image distance.

Other features of the interactive whiteboard include:

- A modular pen tray that automatically detects when you pick up a pen tray pen or the eraser
- Pen tray buttons that activate the pens' colors and the on-screen keyboard, right-click, Orientation and Help functions
- A durable hard-coated surface that is optimized for projection and easily cleaned
- A security cable lock feature that enables you to lock the interactive whiteboard to help safeguard it from theft

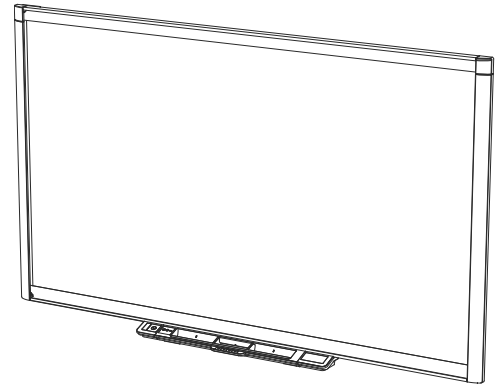

For more information about the SMART Board interactive whiteboard, see the *SMART Board 800 series interactive whiteboard user's guide* (smarttech.com/kb/144817).

SMART U100 or SMART U100w projector

The SMART U100 or SMART U100w projector system includes a short-throw projector for use with SMART Board interactive whiteboards and a sturdy support system suitable for many different environments.

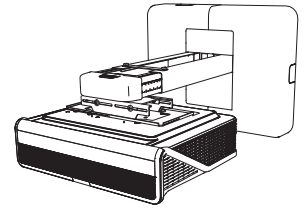

Other features of the projector system include the following:

- A wall-mounted, high-offset projector engine that uses DLP® technology by Texas Instruments™, providing BrilliantColor™ performance and Gamma 2.2 correction with SMART Presentation, Bright Room, Dark Room, sRGB and User modes
- Philips® ImageCare™ lamp control technology extends lamp life
- PAL, PAL-N, PAL-M, SECAM, NTSC and NTSC 4.43 video system compatibility
- HDMI, Composite, and VESA® RGB video inputs
- UXGA, SXGA+, SXGA, WXGA, XGA, SVGA, VGA video format compatibility
- Native 1024 × 768 resolution (SMART U100 projector)

OR

Native 1280 × 800 resolution (SMART U100w projector in 16:10 aspect ratio mode)

- Remote management via a serial RS-232 interface, web page or SNMP
- An alert broadcast feature that enables administrators to send notification messages to network-connected projector systems for immediate on-screen display
- Protected cable routing through a cable cover that limits tampering and clutter

- A secure mounting and installation system that includes the following:
 - An optional projector padlock ring to prevent removal of the projector from the boom
 - Accessory mounting hardware for solid masonry or framed wall installations kit (Part Number 1007416)
 - Templates and instructions for positioning the system safely

Extended Control Panel (ECP)

The projector system ECP attaches to the interactive whiteboard pen tray. The ECP features controls for power, source selection and volume adjustment, as well as a USB A receptacle for USB drives.

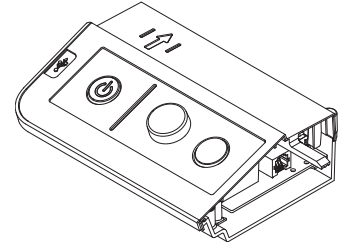

Included accessories

The following accessories are included with the interactive whiteboard system.

Remote control

The remote control enables you to control the system and set up your projector. Use the remote control to access menu options, system information and input selection options.

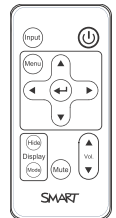

Pens

There are two pens included with the interactive whiteboard. Pick up a pen and press one of the four color buttons on the pen tray (black, red, green or blue) to select the color of digital ink you write on the interactive whiteboard.

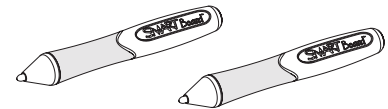

IMPORTANT

Do not substitute the pens with other items, such as dry-erase markers, if Touch Recognition is enabled. (Touch Recognition enables you to pick up a pen tray pen, and then write, select or erase without replacing the pen.)

Eraser

The eraser resembles a rectangular chalkboard eraser. You can use a substitute object, as long as it has a similar shape, reflects infrared light and doesn't scratch or mark the interactive whiteboard surface.

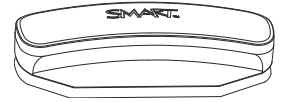

Optional accessories

You can add a variety of accessories to your interactive whiteboard to best meet your specific needs. Purchase these items from your authorized SMART reseller (smarttech.com/where).

For more information on accessories, go to smarttech.com/accessories.

VGA connection kit

The VGA connection kit allows you to connect a laptop to the interactive whiteboard system using a VGA cable. The end of the VGA connection kit can be attached to either side of the interactive whiteboard or to a wall in a convenient location.

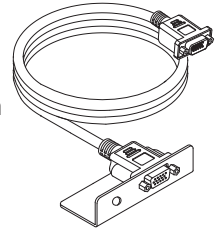

RCA connector pod

The optional RCA connector pod includes two RCA jacks for dual-channel audio input and one for composite video input. You can use the RCA connector pod to connect DVD/Blu-ray players and similar devices (see *Using the optional RCA connector pod* on page 29).

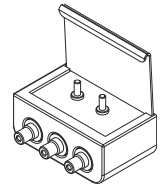

Purchase this item from your authorized SMART reseller.

Chapter 2

Installing the interactive whiteboard system

Choosing a location	7
Choosing a height	8
Securing the interactive whiteboard system	9
Locking the pen tray to the interactive whiteboard	9
Securing the projector to the boom	9
Routing the cables	9
Installing SMART software	10

Consult the SMART Board interactive whiteboard system installation document included with your product for instructions on how to install and secure the system.



IMPORTANT

Use the *SMART Board 800ix3 interactive whiteboard system installation guide* (smarttech.com/kb/170885) to install the interactive whiteboard and projector.

This chapter provides additional considerations and details for installing the interactive whiteboard system.

Choosing a location

Choose a location for the interactive whiteboard system that's far from bright light sources, such as windows and strong overhead lighting. IR lighting can cause issues with the performance of the cameras and can lead to unintentional or missed touches.

Select a wall with a flat, regular surface and sufficient clearance to accommodate the interactive whiteboard system. Install the projector and your interactive whiteboard on the same flat surface. For best presentation alignment, mount the interactive whiteboard system in a location that's central to your audience's viewing direction.

For mobile or adjustable installation options, contact your authorized SMART reseller.

 **WARNING**

- Refer to the interactive whiteboard system's specifications (available at smarttech.com/support) for its weight. Check your local building codes to ensure that your wall can support this weight, and use appropriate mounting hardware for your wall type.
- If you are installing the interactive whiteboard system on drywall, use all the included toggle bolts. If one of the bracket holes aligns with a wall stud, use appropriate hardware in that hole instead of a toggle bolt.

 **CAUTION**

If you're replacing a SMART Board 500 or 600 series interactive whiteboard with the SMART Board 800 series interactive whiteboard on drywall, you must remove the wall-mount bracket and mounting hardware and install all the mounting hardware and brackets supplied with the SMART Board 800 series interactive whiteboard instead.

To help ensure that the interactive whiteboard is mounted correctly, make sure the colors of the wall-mount hanger on the back of the interactive whiteboard and the wall-mount bracket are the same.

Choosing a height

SMART includes a mounting template with each interactive whiteboard system. If you lose this template, contact your authorized SMART reseller. Using this template ensures that you can do the following:

- Mount the projector at a safe height for head space clearance, while maintaining enough space for airflow and installation access above the unit.
- Position the projector at the correct height above the interactive whiteboard to align the projected image with the touch screen.

Dimensions on the template recommend a distance from the floor suitable for adults of average height. Consider the general height of your user community when you choose a location for the interactive whiteboard.

Securing the interactive whiteboard system

This section explains how to secure the different components of the interactive whiteboard system.

Locking the pen tray to the interactive whiteboard

To learn how to lock the pen tray to the interactive whiteboard, see the *SMART Board 800 series interactive whiteboard user's guide* (smarttech.com/kb/144817).

Securing the projector to the boom

The top surface of the projector features a secure metal loop that can accommodate a cable you've secured to the projector boom.

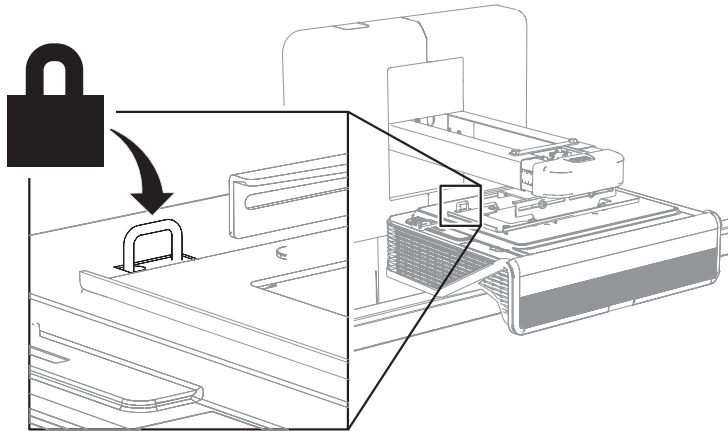

Routing the cables

If the interactive whiteboard uses one mounting bracket, make sure that all projector cables pass along the top of the bracket and then down the side of the interactive whiteboard.

If the interactive whiteboard uses two mounting brackets, make sure that all projector cables pass between the brackets. Space the wall-mounting brackets 4" (10.2 cm) apart to provide full support for the interactive whiteboard's weight.

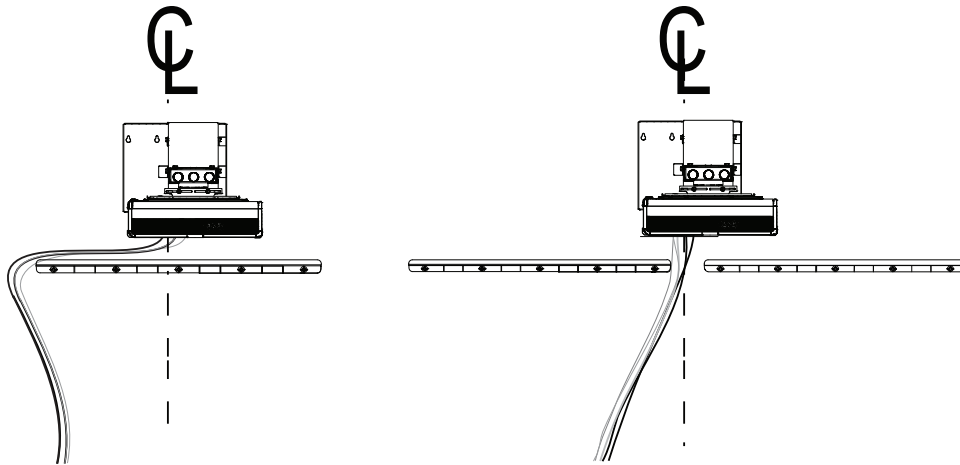

 **IMPORTANT**

Do not connect the power cable to a power outlet until you have connected all the cables to the projector and ECP.

Installing SMART software

To access all the features of the interactive whiteboard system, install SMART software, such as SMART Meeting Pro® software or SMART Notebook® collaborative learning software, on the connected computer.

Download SMART software from smarttech.com/software. These web pages list the minimum hardware requirements for each software version. If SMART software is already installed on your computer, take this opportunity to upgrade the software to ensure compatibility.

Chapter 3

Using the interactive whiteboard system

Using the projector	11
Using the remote control	11
Replacing the remote control battery	12
Using the remote control buttons	13
Adjusting projector settings	14
Focusing the image	24
Adjusting the image	25
Projector connection diagram	25
Using the interactive whiteboard	27
Using the Extended Control Panel (ECP)	27
Using the optional RCA connector pod	29

This chapter describes the basic operation of the interactive whiteboard system and explains how to set up the remote control, retrieve system information, access the projector's image adjustment options and integrate the interactive whiteboard system with peripheral devices.

Using the projector

Using the remote control

The projector remote control enables you to access on-screen projector menus and change projector settings.

Replacing the remote control battery

Follow this procedure to replace the remote control battery.



WARNING

- Reduce the risk associated with a leaking battery in the projector's remote control by following these practices:
 - Use only the specified CR2025 coin-cell battery.
 - Remove the battery when the remote control is unused for an extended period.
 - Do not heat, disassemble, short or recharge the battery, or expose it to fire or high temperatures.
 - Avoid eye and skin contact with the battery if it has a leak.
- Dispose of the exhausted battery and product components in accordance with applicable regulations.

To replace the remote control battery

1. Hold down the side release on the left side of the battery holder and pull the battery holder completely out of the remote control.

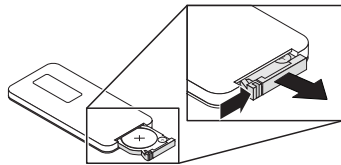

2. Remove the old battery from the battery holder and replace it with a CR2025 coin-cell battery.



IMPORTANT

Align the battery's positive (+) and negative (-) terminals with the correct signs on the battery holder.

3. Insert the battery holder into the remote control.

Using the remote control buttons

The projector remote control enables you to access on-screen menus and change projector settings. Use the **Power**  button on the remote control or ECP to put the projector into Standby mode or to turn it on. You can also use the **Input** button on the remote control or ECP to switch sources on the projector.

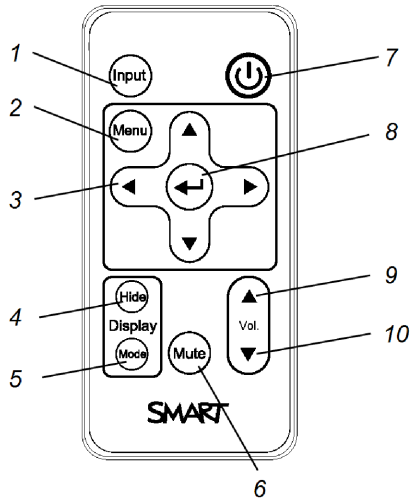

Number	Function	Description
1	Input	Select a video and audio input source on the projector and the associated USB input source on the ECP, if present.
2	Menu	Show or hide the projector menus.
3	◀ (Left), ▶ (Right), ▲ (Up) and ▼ (Down) arrows	Change the menu selections and adjustments.
4	Hide	Freeze, hide or display the image: <ul style="list-style-type: none"> • Press once to freeze the image. For example, you can display a question on the screen while you check your e-mail. • Press again to hide the image, that is, to display a black screen. • Press again to return to the live image.
5	Mode	Select a display mode.
6	Mute	Mute audio amplification.
7	 (Power)	Turn on the projector or put it into Standby mode.
8	↵ (Enter)	Accept the selected mode or option.
9	▲ (Volume Up)	Increase audio amplification volume.
10	▼ (Volume Down)	Decrease audio amplification volume.

 **NOTE**

The **Mute**, **Volume Up** and **Volume Down** buttons work only if there is an audio source connected to the projector for the selected video input source.

Adjusting projector settings

Use the remote control's Menu button to access the on-screen display and adjust the projector settings.

 **IMPORTANT**

Keep the remote control in a safe place because there is no other way to access menu options.

Setting	Use	Notes
 Image Adjustment menu (VGA1 input)		
Display Mode	Indicates the projector's display output (SMART Presentation, Bright Room, Dark Room, sRGB and User).	The default is SMART Presentation .
Brightness	Adjusts projector brightness from 0 to 100.	The default is 50.
Contrast	Adjusts the difference between the lightest and darkest parts of the image from 0 to 100.	The default is 50.
Frequency	Adjusts the display data frequency of the projected image from -5 to 5 to match the frequency of your computer's graphics card.	The default is 0.
Tracking	Synchronizes your projector's display timing with your computer's graphics card from 0 to 63.	
H-Position	Moves the horizontal position of the source video left or right from 0 to 100 (relative to the projected image).	Don't adjust this setting unless you're advised to by SMART Support. Apply this setting only after you make all boom adjustments. This setting is useful in situations where the source video is cut off.

Setting	Use	Notes
V-Position	Moves the vertical position of the source video up or down from -5 to 5 (relative to the projected image).	Don't adjust this setting unless you're advised to by SMART Support. Apply this setting only after you make all boom adjustments. This setting is useful in situations where the source video is cut off.
White Peaking	Adjusts the image color brightness from 0 to 10 while providing more vibrant white shades.	A value closer to 0 creates a natural image and a value closer to 10 increases brightness. The default is 10.
Degamma	Adjusts the color performance of the display from 1 to 3.	The default is 2.
Color	Opens a sub-menu for adjusting the Red, Green, Blue, Cyan, Magenta and Yellow colors on the projector from 0 to 100, providing custom color and luminance output.	Each color has a default value of 100. Adjustments to the color settings register under the User mode.
 Image Adjustment menu (HDMI1 and HDMI2 inputs)		
Display Mode	Indicates the projector's display output (SMART Presentation, Bright Room, Dark Room, sRGB and User).	The default is SMART Presentation .
Brightness	Adjusts projector brightness from 0 to 100.	The default is 50.
Contrast	Adjusts the difference between the lightest and darkest parts of the image from 0 to 100.	The default is 50.
White Peaking	Adjusts the image color brightness from 0 to 10 while providing more vibrant white shades.	A value closer to 0 creates a natural image and a value closer to 10 increases brightness. The default is 10.
Degamma	Adjusts the color performance of the display from 1 to 3.	The default is 2.

Setting	Use	Notes
Color	Opens a sub-menu for adjusting the Red, Green, Blue, Cyan, Magenta and Yellow colors on the projector from 0 to 100, providing custom color and luminance output.	Each color has a default value of 100. Adjustments to the color settings register under the User mode.
 Image Adjustment menu (Composite input)		
Display Mode	Indicates the projector's display output (SMART Presentation, Bright Room, Dark Room, sRGB and User).	The default is SMART Presentation .
Brightness	Adjusts projector brightness from 0 to 100.	The default is 50.
Contrast	Adjusts the difference between the lightest and darkest parts of the image from 0 to 100.	The default is 50.
Saturation	Adjusts the intensity of the video signal's color from 0 to 100.	The default is 50.
Sharpness	Adjusts the video signal's sharpness from 0 to 32, with 0 being the maximum sharpness and 32 being the maximum smoothness. The default setting of 16 leaves the video's sharpness unaffected.	The default is 16.
Tint	Adjusts the video signal's tint from 0 to 100. Adjusting the setting toward 0 makes the image more green. Adjusting the setting toward 100 makes the image more magenta.	The default is 50.
White Peaking	Adjusts the image color brightness from 0 to 10 while providing more vibrant white shades.	A value closer to 0 creates a natural image and a value closer to 10 increases brightness. The default is 10.
Degamma	Adjusts the color performance of the display from 1 to 3.	The default is 2.

Setting	Use	Notes
Color	Opens a sub-menu for adjusting the Red, Green, Blue, Cyan, Magenta and Yellow colors on the projector from 0 to 100, providing custom color and luminance output.	Each color has a default value of 100. Adjustments to the color settings register under the User mode.
 Audio menu		
Line out	Enables or disables the line out.	The default is on.
Microphone	Enables or disables the microphone.	The default is on.
Speaker	Enables or disables the speaker.	The default is on.
Main Volume	Adjusts the projector's volume amplification from 0 to 40.	The default is 20.
Microphone Volume	Adjusts the microphone's volume (gain) from 0 to 40.	The default is 20.
Disable Main Volume Control	Disabling the main volume control maintains the current volume setting even if a user tries to change the volume with the remote control or volume buttons on another device.	The default is off.
Mute	Mutes the projector's audio output.	The default is off. If you mute the projector's audio output and then increase or decrease the volume, the volume is restored automatically. You can prevent this from happening by disabling the volume control.
Closed Captioning	Turns the display of Closed Captions on or off.	The default is off.
CC Language	Chooses the language for Closed Captioning.	The user can choose between CC1 or CC2. The default is CC1.
Advanced	Opens the Advanced Audio sub-menu.	
Advanced Audio sub-menu		
VGA1 Mic	Enables or disables the microphone input while using the VGA1 input.	The default is on.

Setting	Use	Notes
VGA1 Speaker	Enables or disables the speaker output while using the VGA1 input.	The default is on.
HDMI1 Mic	Enables or disables the microphone input while using the HDMI1 input.	The default is on.
HDMI1 Speaker	Enables or disables the speaker output while using the HDMI1 input.	The default is on.
HDMI2 Mic	Enables or disables the microphone input while using the HDMI2 input.	The default is on.
HDMI2 Speaker	Enables or disables the speaker output while using the HDMI2 input.	The default is on.
Composite Mic	Enables or disables the microphone input while using the Composite input.	The default is on.
Composite Speaker	Enables or disables the speaker output while using the Composite input.	The default is on.
Microphone Boost	Boosts the microphone gain by 20dB.	The default is off.
Exit	Closes the Advanced Audio sub-menu.	
 Operational Settings menu		
Signal Detect	Enables or disables the automatic detection of an active signal source.	<p>The default is off.</p> <p>When On, the projector continuously switches inputs until it finds an active video source.</p> <p>When Off, the projector maintains signal detection in one input.</p>
Lamp Reminder	Turns the lamp replacement reminder on or off.	This reminder appears 100 hours before the recommended lamp replacement.
Lamp Mode	Adjusts lamp brightness to Standard or Economy .	<p>Standard displays a high-quality, bright image.</p> <p>Economy increases the lamp life by decreasing the brightness of the image.</p>

CHAPTER 3
USING THE INTERACTIVE WHITEBOARD SYSTEM



Setting	Use	Notes
ImageCare	Turns ImageCare on or off.	The default is off.
Keystone	Adjusts the size of the top and bottom edge with a range of -15 to 15.	The default is 0. Ensure that the top and bottom edges of the image are horizontal before you position the left and right edges of the image relative to the interactive whiteboard.
USB 1 Source Select	Maps the USB port to Video input.	The default is HDMI1 .
USB 2 Source Select	Maps the USB port to Video input.	The default is VGA1 .
Auto Power Off	Sets the length of the auto power-off countdown timer between 1 and 240 minutes.	The default is 15 minutes. The timer begins to count down when the projector no longer receives a video signal. The timer finishes when the projector enters Standby mode. Select 0 to turn off the timer. Select 120 to enable proper functioning of ImageCare.
Zoom	Adjusts the zoom to the center of the image in or out from 0 to 30.	The default is 0. Zooming in cuts off the outer edges of the source video.
Projector ID	Displays the projector's unique ID number (from 000 to 999) within your organization's network.	You can refer to or change this number when using the network remote management feature (see <i>Remotely managing the system through a network interface</i> on page 57).

Setting	Use	Notes
Aspect Ratio	Adjusts the image output to Fill Screen , Match Input or 16:9 .	<p>The default is Fill Screen.</p> <p>Fill Screen produces an image that fills the entire screen by stretching and scaling the source video to match the projector's native resolution and aspect ratio.</p> <p>Match Input displays the source video in its native resolution and aspect ratio. As a result, unused space could appear along the top and bottom edges of the screen (letterbox format) or along the left and right edges of the screen (pillarbox format).</p> <p>16:9 displays the source video in 16:9 aspect ratio. As a result, unused space appears along the top and bottom edges of the screen. This is recommended for use with HDTV and DVD/Blu-ray discs enhanced for wide-screen televisions.</p> <p>See <i>Video format</i> on page 95 for descriptions of each mode.</p>
Startup Screen	Opens the Startup Screen sub-menu, in which the user can select the type of startup screen (SMART , Capture User Startup Screen , Preview Startup Screen), or Image Alignment Screen .	<p>This screen displays when the projector lamp is starting and a video source signal isn't displayed.</p> <p>SMART displays the default SMART logo on a blue background.</p> <p>Capture User Startup Screen closes the on-screen display menu and captures the entire projected image. The captured image is displayed the next time the on-screen display opens. (The capture can take up to one minute, depending on the complexity of the background graphic.)</p> <p>Preview Startup Screen enables you to preview the default or captured startup screen.</p> <p>Image Alignment Screen enables you to adjust the projected image size, shape and location.</p>

Setting	Use	Notes
Default	Opens the Reset to Default screen, in which the user can reset the projector settings to their default values.	If you select Yes , all projector settings reset to their defaults, reversing any menu changes you made. This action is irreversible. Don't adjust this setting unless you want to reset all of the applied settings, or unless you're advised to by a SMART Support specialist.
 Network menu		
Network and VGA Out	Activates the projector's RJ45 (8P8C) connector and network features.	
Status	Displays the current network status (Connected , or Disconnected).	The default is Disconnected .
DHCP	Displays the status of the network's Dynamic Host Configuration Protocol (DHCP) as On or Off .	The default is off. On enables a DHCP server on the network to assign an IP address to the projector automatically. Off enables an administrator to assign an IP address manually.
Password Reminder	Emails the network password to the email address selected in advance.	See <i>Web page management</i> on page 57 to set up a destination email address.
IP Address	Displays the projector's current IP address in values between 0.0.0.0 and 255.255.255.255.	To change the projector's IP address, use the RS-232 connector or use a DHCP server to assign a dynamic IP address, and then set a static IP address using the network remote management feature (see <i>Remotely managing the system through a network interface</i> on page 57).
Subnet Mask	Displays the projector's subnet mask number in values between 0.0.0.0 and 255.255.255.255.	
Gateway	Displays the projector's network gateway in values between 0.0.0.0 and 255.255.255.255.	

CHAPTER 3
USING THE INTERACTIVE WHITEBOARD SYSTEM

Setting	Use	Notes
DNS	Displays the projector's domain name server IP address in values between 0.0.0.0 and 255.255.255.255.	
MAC Address	Displays the projector's MAC address in xx-xx-xx-xx-xx-xx format.	
Group Name	Displays the projector's workgroup name as set by an administrator (maximum 16 characters).	You can set the projector's workgroup name using the remote management features (see <i>Remotely managing the system through a network interface</i> on page 57 and <i>Remotely managing the system through an RS-232 serial interface</i> on page 67).
Projector Name	Displays the projector's name as set by an administrator (maximum 16 characters).	You can set the projector's name using the remote management features (see <i>Remotely managing the system through a network interface</i> on page 57 and <i>Remotely managing the system through an RS-232 serial interface</i> on page 67).
Location	Displays the projector's location as set by an administrator (maximum 16 characters).	You can set the projector's location using the remote management features (see <i>Remotely managing the system through a network interface</i> on page 57 and <i>Remotely managing the system through an RS-232 serial interface</i> on page 67).
Contact	Displays the contact email address for projector support as set by an administrator (maximum 16 characters).	You can set the contact name or number using the remote management features (see <i>Remotely managing the system through a network interface</i> on page 57 and <i>Remotely managing the system through an RS-232 serial interface</i> on page 67).

Setting	Use	Notes
 Language menu		
Language	Selects the language used in the projector menus.	Projector menu support is available in English (U.S.), English (UK) French, German, Dutch, Danish, Finnish, Italian, Norwegian, Russian, Spanish, Swedish, Portugese, Chinese (Simplified), Chinese (Traditional), Czech, Hungarian, Japanese, Malayasian, Polish, Romanian, Arabic, Turkish, Greek, Slovak, Korean and Hebrew. (U.S. English is the default.)
 Information menu		
Lamp Hours	Displays the current number of lamp usage hours from 0 to 9999 hours from when it was last reset.	Always reset the lamp hours after you replace a lamp, because lamp service reminders are based on the current hours of use. See <i>Resetting the lamp hours</i> on page 40 for details on the lamp hours reset procedure.
Input	Displays the currently active video input source (VGA1 , Composite , HDMI1 , or HDMI2).	Default is VGA1 .
Resolution	Displays the projector's most recently detected video source signal resolution and refresh rate.	If no video source is currently active, this setting displays the last known source signal image resolution and refresh rate.
DDP	Displays the projector's digital display processor (DDP) firmware version in x.x.x.x format.	
MPU	Displays the projector microprocessor unit (MPU) firmware version in x.x.x.x format.	
Network Version	When the Network and VGA Out setting is enabled, displays the projector's network communications processor firmware version in x.x.x.x format.	If the Network and VGA Out setting is not enabled, 0.0.0.0 appears.

Setting	Use	Notes
Model Number	Displays the projector's model number (SMART U100 or SMART U100w).	
Serial Number	Displays the projector's serial number.	

Focusing the image

Use the projector's focus slider to focus the projected image.

To focus the image

Adjust the Focus slider until the image is in focus.

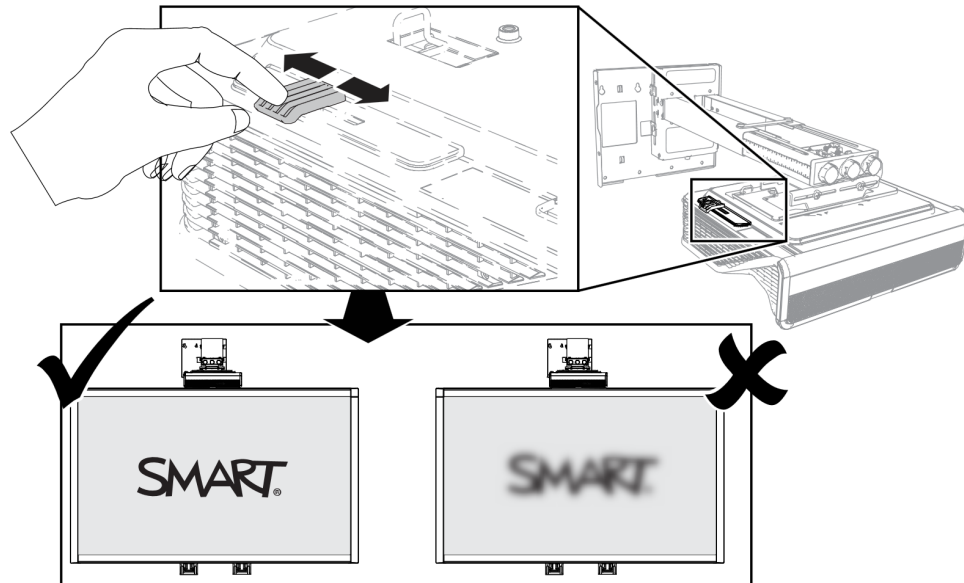

Adjusting the image

Refer to these notes when adjusting the projected image as described in the included *SMART Board 800ix3 interactive whiteboard system installation guide* (smarttech.com/kb/170885).

- While adjusting the projected image size, shape and location, use the projector's default background so that you can see the full projected image clearly. Don't use other images, which might be cropped or scaled by the projector and could result in a misleading projected image size, shape and location.
- Use the mechanical adjustments described in the installation document to make all physical image adjustments. Don't use the projector's on-screen menu options during the projector alignment process.
- Be aware that as you tilt the projector up or lower its mounting boom to raise the image, the entire projected image increases or decreases in size, especially at the bottom of the projected image.
- When adjusting keystone (tilt), ensure that the top and bottom edges of the image are horizontal before you position the left and right edges of the image relative to the interactive whiteboard.
- When you move the projector forward or backward on the boom to make the image larger or smaller, you might need to tilt or turn the projector slightly to keep the image square. Loosen the lever slightly to aid in this adjustment.
- To fine-tune the image, you might need to repeat all steps described in the installation document in smaller increments.

Projector connection diagram

You can connect a variety of peripheral devices to the projector, including DVD/Blu-ray players, VCRs, HDMI streaming devices, document cameras, digital cameras and high-definition sources, as well as peripheral device outputs, such as a secondary projector or a flat-panel display and powered speakers.

NOTE

You might need to purchase third-party adapters to connect certain peripheral devices.

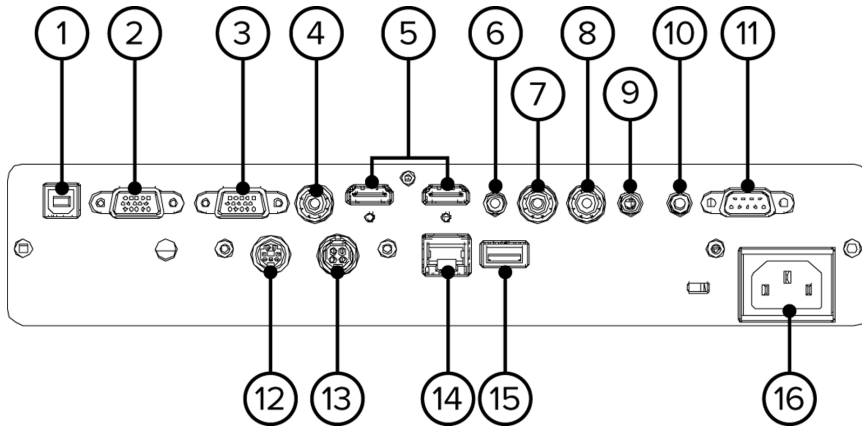

No.	Connector	Connect to:
1	USB B	Computer (for service access only)
2	DB15F (DE-15F) RGB video output (VGA Out)	Secondary display (not included)
3	DB15F (DE-15F) RGB video input (VGA1)	Primary computer (not included)
4	RCA Composite video input	Video source (not included)
5	HDMI1 and HDMI2 inputs	High-definition video and audio sources (not included)
6	3.5 mm phone jack VGA1 audio input	Audio sources associated with primary and secondary computers
7	Right RCA audio input	Audio source for composite video (not included)
8	Left RCA audio input	Audio source for composite video (not included)
9	3.5 mm phone jack microphone	Microphone (not included)
10	3.5 mm phone jack audio output	Speakers (not included)
11	DB9F (DE-9F) RS-232	Room control system or other terminal device (not included)
12	7-pin mini-DIN	ECP control
13	4-pin power mini-DIN 5V/2A output	ECP power (5v/2A)
14	RJ45 (8P8C)	Network (for web page management and SNMP access)
15	USB A receptacle, power only +5 VDC	HDMI streaming device (not included)
16	Power	Mains power supply

NOTES

- To connect the interactive whiteboard, see the *SMART Board 800ix3 interactive whiteboard system installation guide* (smarttech.com/kb/170885).
- To connect accessories to the interactive whiteboard, refer to the documents included with the accessories and consult the SMART Support website (smarttech.com/support) for additional information.

Using the interactive whiteboard

Refer to the *SMART Board 800 series interactive whiteboard user's guide* (smarttech.com/kb/144817) for in-depth information on using the interactive whiteboard and its features.

When you connect the SMART Board interactive whiteboard to a computer that has SMART software installed, you can access the interactive whiteboard's full capabilities.

For more information on this software, press the **Help** button on your interactive whiteboard pen tray.

For additional resources, go to smarttech.com/support, where you'll find up-to-date, product-specific information, including setup instructions and specifications.

The SMART training website (smarttech.com/training) includes an extensive library of training resources you can consult as you learn to set up or use the interactive whiteboard system.



Using the Extended Control Panel (ECP)

The ECP gives you control of the basic operations of the interactive whiteboard system. Press the **Power**  button on the ECP or remote control to put the projector system into Standby mode or turn it on. Press the **Input** button on the ECP or remote control to switch sources on the projector.

IMPORTANT



- Keep the remote control in a safe place because there is no other way to access menu options.
- Do not disconnect cables from the ECP to connect peripheral devices because you could disconnect controls for your interactive whiteboard.

 **NOTES**

- For more details on the interactive whiteboard system’s status, go to *Determining the interactive whiteboard system’s status* on page 44.
- Low Power mode reduces the interactive whiteboard system’s power consumption when it is in Standby mode. To set the projector system to enter Low Power mode automatically whenever it enters Standby mode, hold down the **Power**  and **Input** buttons at the same time for five seconds. After five seconds, the **Power**  button blinks amber for two seconds to indicate that Low Power mode is enabled.

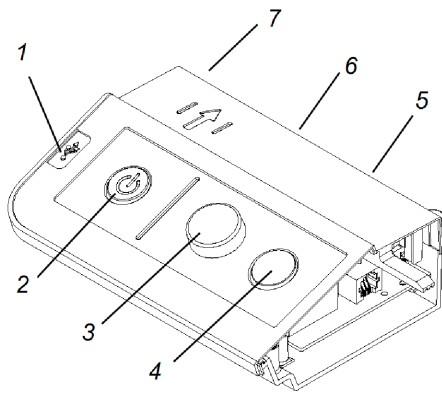
The following diagram and table describe the components of the Extended Control Panel.



Number	Function
Left side	
1	USB A receptacle (for USB drives)
<div style="background-color: #f0f0f0; padding: 5px;"> <p> NOTE USB drives that you connect to this receptacle are accessible only to the room computer (the computer connected to the USB1 receptacle).</p> </div>	
Front	
2	Power  button and status indicator light
3	Volume control
4	Input selection
Back	
5	Two mini USB B receptacles (connect to room computer and laptop)
6	11-pin connector (connects to ECP cable harness)
7	4-pin connector (for optional room control)

 **NOTE**

Use an 800 series control cable (Part No. SBX8-CTRL) to convert the 4-pin connector to a DB9F RS-232 connector for use with a third-party room control system. You can purchase an SBX8 series control cable from your local SMART reseller.

 **TIP**

If your computer has an HDMI output, you can connect a USB cable from your computer to either of the USB B receptacles on the ECP and an HDMI cable from your computer to the HDMI connector on the projector. Associate the HDMI source with the appropriate USB receptacle (see *Adjusting projector settings* on page 14). Press the **Input** button on the ECP to switch to the HDMI input.

Using the optional RCA connector pod

Use the optional RCA connector pod to connect DVD/Blu-ray players and similar devices.

The following diagram and table describe the components of the RCA connector pod.

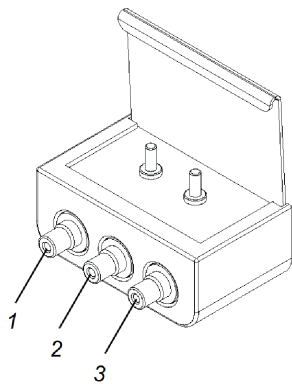

Number	Function
1	RCA composite video input jack (for peripheral devices such as a DVD/Blu-ray player)
2	RCA audio jack (right input)
3	RCA audio jack (left input)

Chapter 4

Maintaining the interactive whiteboard system

Maintaining the interactive whiteboard	31
Preventing damage to the interactive whiteboard	31
Keeping the writing surface clean	32
Cleaning the pen tray	32
Cleaning the projector	32
Focusing and adjusting the projector image	33
Replacing the projector lamp	33
Removing and replacing the projector lamp module	33
Resetting the lamp hours	40

This chapter includes methods for properly cleaning and preventing damage to the SMART Board interactive whiteboard system.

Maintaining the interactive whiteboard

For information on maintaining the interactive whiteboard, see the *SMART Board 800 series interactive whiteboard user's guide* (smarttech.com/kb/144817).

With proper care, the SMART Board interactive whiteboard will provide years of trouble-free service.

Preventing damage to the interactive whiteboard

Although the interactive whiteboard's surface is very durable, take the following precautions to prevent damage.

- Don't use sharp or pointed objects, such as ballpoint pens or pointers, as writing tools.
- Replace the pen nib when the nib wears out.
- Don't use low-odor dry-erase markers because they can be very difficult to erase. Use standard (high-odor) dry-erase markers that show a warning to use them only in well-ventilated areas.

- Don't use adhesive tape on the interactive surface.
- Don't use abrasive erasers or harsh chemicals to clean the product.
- Don't use compressed air to clean the interactive whiteboard's cameras because the force of the air could damage them.

Keeping the writing surface clean

Follow these tips to keep the interactive whiteboard's surface clean.

- Clean the interactive whiteboard at least every six months.
- Don't spray cleaner directly onto the interactive whiteboard's surface. Instead, spray a light amount of cleaner on a cloth and then gently wipe the interactive surface.
- Don't allow excess cleaner to flow onto the frame's reflective surfaces or into the pen tray slots.



IMPORTANT

Turn off the interactive whiteboard system before you clean it so that you do not scramble the desktop icons or inadvertently activate applications when you wipe the interactive surface.



TIP

To view dirt or streaks more easily, set the projector to Standby (lamp off) mode.

Cleaning the pen tray

If the infrared sensors in the sides of the pen tools' slots become obstructed by dirt, spray an alcohol-free household glass cleaner, such as Windex cleaner, on a cotton swab and then carefully clean the infrared transmitter and receiver.

Cleaning the projector



WARNING

Cleaning a wall-mounted projector can result in a fall or injury. Use caution when climbing a ladder, and consider removing the projector from its wall-mounting bracket to clean it.



CAUTION

- Never scrub the mirror cover with a cleaning cloth or touch the mirror cover with your hands or a brush. Instead, clean the mirror cover as you would clean a lens, using lens cleaning

tissue and no solvents. Do not apply pressure to the mirror cover, and do not use cleaning products designed for touch screens or monitors.

- Before you clean the projector, press the **Power**  button twice on the ECP or remote control to put the system in Standby mode, and then allow the lamp to cool for at least 30 minutes.
- Do not spray cleaners, solvents or compressed air directly on the projector. Do not use spray cleaners or solvents near any part of the projector because they can damage or stain the unit. Spraying the system could spread a chemical mist on some of the projector's components and lamp, resulting in damage and poor image quality.
- Do not allow liquids or commercial solvents of any kind to flow into the projector base or head.
- If wiping the mirror cover is unavoidable, wear protective gloves and gather the cleaning cloth into a ball. Gently run the cleaning cloth across the lens mirror from the center to the edge, using the cleaning cloth as you would a feather duster. Don't apply pressure to the mirror cover.



IMPORTANT

- When cleaning the interactive whiteboard system:
 - Wipe the exterior of the projector with a lint-free cloth.
 - If necessary, use a soft cloth moistened with a mild detergent to clean the projector housing.
- Do not use abrasive cleaners, waxes or solvents.

Focusing and adjusting the projector image

For information on focusing and adjusting the projector image, see *Focusing the image* on page 24 and *Adjusting the image* on page 25.

Replacing the projector lamp

This section provides instructions for replacing the projector lamp module.

Removing and replacing the projector lamp module

Eventually the lamp will dim and a message will appear reminding you to replace the lamp. Make sure you have a replacement lamp module before you proceed with the following instructions.



WARNING

- See [smarttech.com/compliance](https://www.smarttech.com/compliance) for the projector's MSDS documents.
- Replace the lamp module when the projector displays its lamp life warning message. If you continue to use the projector after this message appears, the lamp can shatter or burst, scattering glass throughout the projector.
- If the lamp shatters or bursts, leave and then ventilate the area.

Next do the following:

- Avoid touching the glass fragments because they can cause injury.
 - Wash your hands thoroughly if you have come into contact with lamp debris.
 - Thoroughly clean the area around the projector, and discard any edible items placed in that area because they could be contaminated.
 - Call your authorized SMART reseller for instructions. Do not attempt to replace the lamp.
- Replacing the lamp module in a wall-mounted projector can result in a fall or injury. Use caution when climbing a ladder, and consider removing the projector from the wall-mounting bracket to replace the lamp module.
 - Uncovering the lamp while the projector is mounted on the wall-mounting bracket can lead to product damage or personal injury from falling pieces of glass if the lamp is broken.

- When replacing the projector lamp module:
 - Put the projector into Standby mode and wait 30 minutes for the lamp to cool completely.
 - Do not loosen or remove any screws other than those specified in the lamp replacement instructions.
 - Wear protective eyewear while changing the lamp module. Failure to do so can cause injuries including loss of eyesight if the lamp shatters or bursts.
 - Use only replacement lamp modules approved by SMART Technologies. Contact your authorized SMART reseller for replacement parts.
 - Never replace the lamp module with a previously used lamp module.
 - Always handle the fragile lamp assembly with care to prevent premature lamp failure or exposure to mercury. Use gloves when touching the lamp module. Do not touch the lamp with your fingers.
 - Recycle or dispose of the lamp module as hazardous waste in accordance with local regulations.

You need a Phillips No. 2 screwdriver to complete these procedures.

To remove the old lamp module

1. Switch off the power to the projector by pressing the **Power**  button on the remote control.
2. Allow the projector to cool for at least 30 minutes.
3. Disconnect the power cable from the projector.

4. Open the lamp cover.

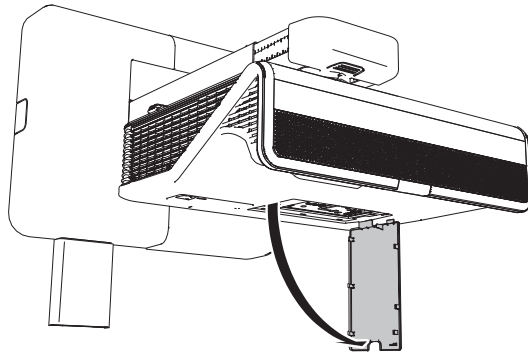

5. Use a Phillips screwdriver to loosen the two captive screws from the bottom of the lamp module.

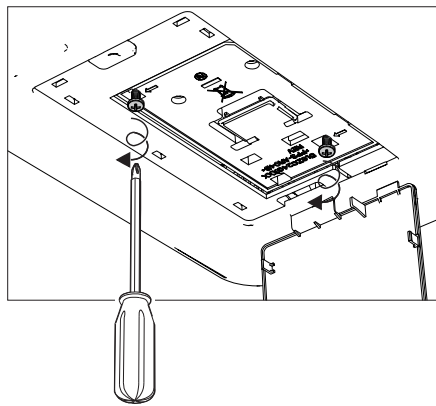

NOTE

Don't try to remove these screws. Captive screws can't be removed, only loosened.

6. Pull up the lamp handle carefully.

7. Remove the lamp module

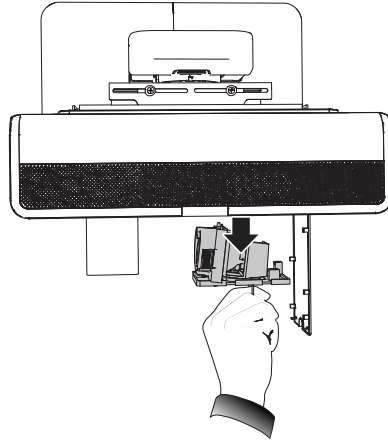

To put the new lamp module into the projector

1. Remove the new lamp module from its packaging.
2. Carefully place the lamp module into the projector and gently press the power end of the lamp module against the projector to ensure the power plug makes contact with the projector's power receptacle.

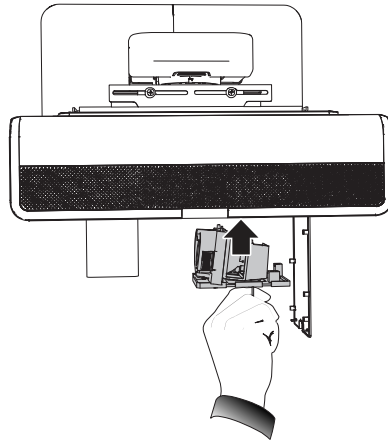

NOTE

You should be able to place the lamp module into the projector easily without applying much force.

3. Use the Phillips screwdriver to secure the captive screws.

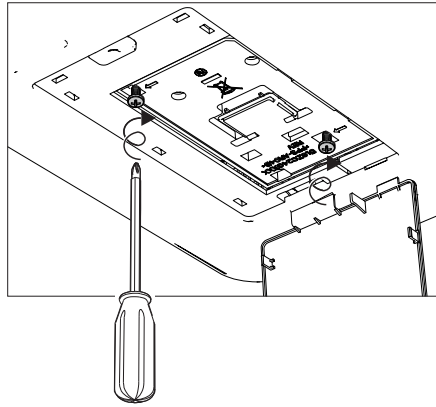

IMPORTANT

Do not over-tighten the screws.

4. Close the lamp cover.
5. Connect the power cable to the wall outlet.
6. Press the **Power**  button once on the remote control to confirm that the projector is operating and that the lamp module is correctly installed.
7. Put the old lamp module in a secure container, and handle it gently until you recycle it.

To finish the projector lamp module installation

1. Turn on the projector.
2. Adjust the projector image if necessary (see *Adjusting the image* on page 25).
3. Access the service menu to reset the lamp hours (see *Resetting the lamp hours* on the next page).
4. Activate the projector's alert emails and lamp warnings if they've been deactivated (see *Email alerts* on page 63 and *Control panel* on page 58).

Resetting the lamp hours

After you replace the lamp module, access the projector service menu to reset the lamp hours. To prevent errors, only a system administrator should perform this procedure.

NOTE

Always reset the lamp hours after you replace the lamp, because lamp service reminders are based on the current hours of use.

To reset the lamp hours

1. Using the remote control, press the following buttons quickly to access the service menu:
Down, Up, Up, Left, Up.

CAUTION

Do not adjust any settings in the service menu other than those listed in this guide. Changing other settings can damage or affect the operation of the projector and may invalidate the warranty.

2. Scroll down to *Lamp Hour Reset*, and then press **OK**.

CAUTION

Do not reset the lamp hours unless you have just replaced the lamp module. Resetting the lamp hours on an old lamp can damage your projector as a result of lamp failure.

NOTE

The *Display Hour* value cannot be reset because it's the running total of hours the projector has been in use.

3. Press the **Menu** button on the remote control.
The *SMART U100 Settings* menu appears.
4. Select  to confirm that *Lamp Hour* is reset to zero.

Chapter 5

Troubleshooting the interactive whiteboard system

Before you start	42
Locating status lights	42
Locating serial numbers	43
Determining the interactive whiteboard system's status	44
U100 and U100w projector status lights	45
Resolving interactive whiteboard issues	46
Resolving operation issues	46
Resolving connection issues	47
Resolving controller module issues	47
Resolving projector errors	48
The projector stops responding	48
The "Lamp Failure" message appears	48
The projector Power and Service lights are off	48
Resolving image issues	49
Loss of signal	49
Partial, scrolling or incorrectly displayed image	50
Unstable or flickering image	50
Frozen image	51
The image doesn't fit the interactive whiteboard	51
The image from a connected laptop computer isn't projected	51
Unaligned projected image	52
Resolving audio issues	52
Resolving ECP issues	53
Resolving network communication issues	53
Accessing the service menu	54
Retrieving your password	54
Resetting the projector	55
Transporting the interactive whiteboard system	55

This chapter provides basic troubleshooting information for the interactive whiteboard system.

For issues not covered in this chapter, consult the SMART Support website (smarttech.com/support) or contact your authorized SMART reseller (smarttech.com/where).



Before you start

Before you troubleshoot the interactive whiteboard system or contact SMART Support or your authorized SMART reseller for assistance, you need to do the following:

- Locate the interactive whiteboard system's status lights.
- Locate the interactive whiteboard system's serial numbers.

Locating status lights

The interactive whiteboard system consists of several components, and each has its own status light:

- The interactive whiteboard's Ready light is located on the pen tray.
- The projector's Power , Service  light, and Diagnostic Indicator are located on the bottom of the projector.

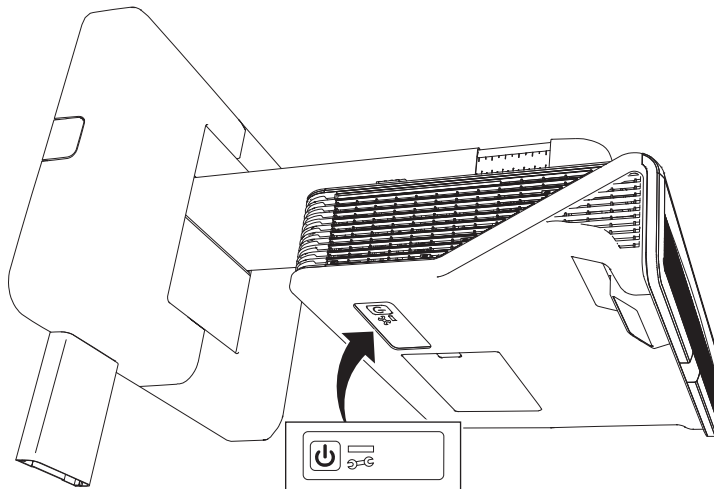

- The ECP's **Power**  button (see *Using the Extended Control Panel (ECP)* on page 27) also functions as a status light.

Locating serial numbers

The serial number for the SMART Board 800 series interactive whiteboard is located on the lower-right edge of the interactive whiteboard's frame. For more information, see the *SMART Board 800 series interactive whiteboard user's guide* (smarttech.com/kb/144817).

The SMART U100 and U100w projector's serial number is located in two places: one next to the mirror cover and the other on the top of the projector.

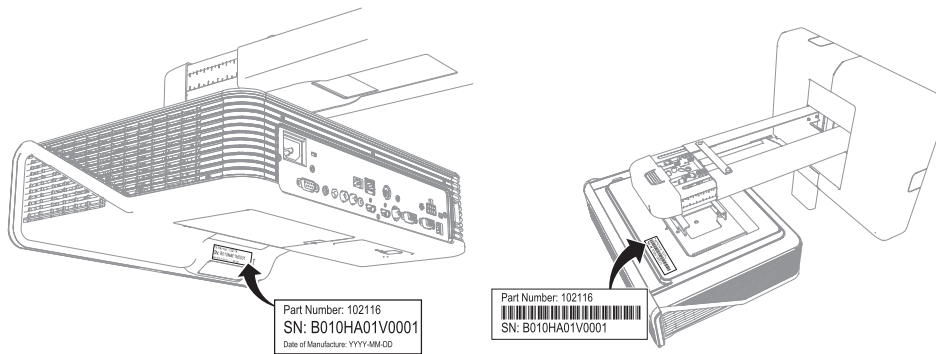



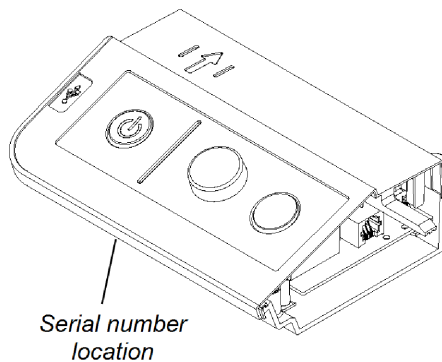

The ECP has its own serial number, which is different from the interactive whiteboard serial number. The ECP serial number is located on the bottom of the ECP.







For the locations of serial numbers on other components and accessories, see smarttech.com/support.

Determining the interactive whiteboard system's status

Use the following table to determine the status of the interactive whiteboard system:



 Projector Power light	 Projector Service light	 ECP light	 Interactive whiteboard Ready light	Projected image	Touch and pen control	Status and related troubleshooting
Normal operating statuses						
Solid green	Off	Solid green	Solid green	Correct	Full control	The system is operating normally. If image or sound issues occur, see the remaining sections of this chapter for troubleshooting information.
Flashing green	Off	Flashing green	Off	None	None	The system is starting up.
Solid amber	Off	Solid amber	Off	None	None	The system is in Standby mode.
Flashing amber	Off	Flashing amber	Off	None	None	The system is entering Standby mode.
Solid green	Off	Solid green	Solid amber	N/A	None	The interactive whiteboard's controller module is starting up. If this process takes longer than 10 seconds, see <i>Resolving controller module issues</i> on page 47.
Solid green	Off	Solid green	Flashing amber	N/A	N/A	The interactive whiteboard's controller module is ready to receive a firmware update or is applying a firmware update. If the Ready light flashes amber but no firmware update appears on the screen, see <i>Resolving controller module issues</i> on page 47.
Error statuses						
Solid green	Off	Solid green	Solid green	Incorrect	Full control	There's an issue with the projected image. See <i>Resolving image issues</i> on page 49.
Solid green	Off	Solid green	Solid green	Correct	None	There's an issue with the interactive whiteboard. See <i>Resolving operation issues</i> on page 46.
Solid green	Off	Solid green	Flashing green	Correct	Touch only	SMART Product Drivers isn't installed or running correctly on the connected computer.
Solid green	Off	Solid green	Off OR Solid red	N/A	None	There's an issue with the connections between the interactive whiteboard and the other components of the system. See <i>Resolving connection issues</i> on page 47.



CHAPTER 5
TROUBLESHOOTING THE INTERACTIVE WHITEBOARD SYSTEM

 Projector Power light	 Projector Service light	 ECP light	 Interactive whiteboard Ready light	Projected image	Touch and pen control	Status and related troubleshooting
Solid green	Off	Off	Off OR Solid red	N/A	N/A	The ECP isn't receiving power. See <i>Resolving ECP issues</i> on page 53.
Solid amber	Flashing red	N/A	N/A	None	N/A	There's an issue with the projector lamp. See <i>The "Lamp Failure" message appears</i> on page 48.
Off	Flashing red	N/A	Off	None	None	The projector's operating temperature has been exceeded. See <i>Resolving projector errors</i> on page 48.
Off	Solid red	N/A	N/A	None	N/A	There's an issue with the projector's fan or color wheel. See <i>Resolving projector errors</i> on page 48.
Off	Off	Off	Off	None	None	The projector power cable isn't properly connected. OR There's an issue with the mains power supply (for example, the circuit breaker is off).

U100 and U100w projector status lights

A code appears on the projector's diagnostic indicator if the projector encounters an error. Use the following table to interpret the codes.

Lamp state	 Power LED	 Projector Service light	Diagnostic Indicator	Description	Remedy
On	Solid green	Solid red	Lh	Lh = Lamp hours reminder After the projector starts, a message appears on-screen telling the user to replace the lamp soon. The message disappears after a moment. The Lh code remains.	Order a new lamp soon.
Off	Flashing red	Flashing amber	LH	LH = Lamp voltage too high The projector has detected that the lamp voltage is too high for safe operation.	Replace the lamp.
Off after failing to turn on	Flashing amber	Flashing amber	LF	LF = Lamp failure The lamp failed to turn on after several attempts.	Wait 20 minutes, and then try to turn the projector on again. If the condition persists, replace the lamp.

Lamp state	Power LED 	Projector Service light 	Diagnostic Indicator	Description	Remedy
Off	Flashing red	Flashing red	OH	OH = Thermal sensor overheat The projector has over-heated and shut down automatically. The system can be restarted to resume normal operation.	The projector may require cleaning, or the operating environment is too hot. It may be possible to resume normal operation if the lamp has been turned off for at least 30 minutes and operating environment has cooled down.
Off	Flashing red	Flashing red	dH	dH = Lamp driver overheat The projector has over-heated and shut down automatically. The system can be restarted to resume normal operation.	The projector may require cleaning, or the operating environment is too hot. It may be possible to resume normal operation if the lamp has been turned off for at least 30 minutes and operating environment has cooled down.
Off	Solid red	Solid red	LF	LF = Lamp failure	If the condition persists, replace the lamp.
			LH	LH = Lamp voltage too high	Replace the lamp.
			F1	F1 = System fan 1 failure	Contact SMART Support.
			F2	F2 = System fan 2 failure	
			F3	F3 = System fan 3 failure	
			F4	F4 = Blower fan failure	
			FC	FC = Color wheel failure	
			PS	PS = 12 VDC failure	
			FP	FP = DDP processor failure	
			Fd	Fd = DmD failure	
Fb	Fb = Lamp driver (ballast) failure				

Resolving interactive whiteboard issues

This section includes information on resolving issues with the interactive whiteboard.

For information not covered in this section, see the *SMART Board 800 series interactive whiteboard user's guide* (smarttech.com/kb/144817).

Resolving operation issues

To resolve operation issues, complete the following tasks:

- Confirm that the camera system cable is connected to the back of the pen tray.
- Perform the calibration procedure documented in the *SMART Board 800 series interactive whiteboard user's guide* (smarttech.com/kb/144817).

- If necessary, complete additional troubleshooting with the guidance of SMART Support using SMART Board Diagnostics.
- Confirm that the camera system cable is connected to the back of the pen tray.
- Reset the interactive whiteboard system. If necessary, complete additional troubleshooting with the guidance of SMART Support using SMART Board Diagnostics.

Resolving connection issues

To resolve connection issues, complete the following tasks:

- Confirm that the ECP cable harness's 4-pin power mini-DIN connector is properly connected to the **DC 5V 2A** connector on the projector.
- Confirm that the ECP cable harness's DB9M RS-232 connector is properly connected to the **Control** connector on the projector.
- Confirm that the USB cable, which is located on the underside of the pen tray, is properly connected from the interactive whiteboard to the ECP.
- If necessary, complete additional troubleshooting on any devices between the USB connection from the computer to the interactive whiteboard system, including any USB hubs and extension cables.



NOTES

- If you're using the CAT 5 USB extender, see *Troubleshooting tips for the CAT 5 USB extender for SMART Board 800 series interactive whiteboards* (smarttech.com/kb/147499).
- Computers connected to the ECP override computers connected to the CAT 5 USB extender. If you connect two computers to the ECP, any computer connected to the CAT 5 USB extender doesn't have a data connection to the interactive whiteboard.

Resolving controller module issues

If the controller module takes longer than 10 seconds to start, disconnect the interactive whiteboard's power cable, wait 10 seconds, and then reconnect it.

If the issue persists, update the firmware as documented in the *SMART Board 800 series interactive whiteboard user's guide* (smarttech.com/kb/144817).

If the Ready light indicates that a firmware update is in progress but no update is actually taking place, disconnect the interactive whiteboard's power cable, wait 10 seconds, and then reconnect it.

Resolving projector errors

System administrators can resolve the following projector errors on their own before contacting SMART Support. Performing initial troubleshooting on the projector reduces the time of a support call.

The projector stops responding

If the projector stops responding, perform the following procedure.

To restart an unresponsive projector

1. Put the projector into Standby mode, and then wait 30 minutes for it to cool down.
2. Disconnect the power cable from the power outlet, and then wait at least 60 seconds.
3. Connect the power cable, and then turn on the projector.

The “Lamp Failure” message appears

If the “Lamp Failure” message appears, one of the following issues is occurring:

- The lamp is overheating, likely due to blocked air vents.
- The lamp has reached the end of its life.
- The projector has an internal problem.

To resolve the “Lamp Failure” error

1. Replace the lamp module as described in *Removing and replacing the projector lamp module* on page 33.
2. If replacing the lamp module doesn't resolve the issue, put the projector into Standby mode, disconnect the power cable, and then contact your authorized SMART reseller.

The projector Power and Service lights are off

If the projector Power and Service lights are both off, one of the following issues is occurring:

- There was a power outage or a power surge.
- A circuit breaker or a safety switch was tripped.
- The projector isn't connected to the power source.
- The projector has an internal problem.

To resolve the unlit projector Power and Service lights issue

1. Check the power source, and then make sure that all cables are connected.
2. Confirm that the projector is connected to an active power outlet.
3. Make sure the pins on the connectors aren't broken or bent.
4. Connect the power cable, and then turn on the projector.
5. If the previous steps don't resolve the issue, disconnect the power cable and then contact your authorized SMART reseller.

Resolving image issues

To resolve common image issues, complete the following tasks:

- Ensure the computer or other video source is on and set to display a resolution and refresh rate supported by the projector (see *Video format* on page 95).
- Ensure the video source is properly connected to the projector.
- Press the Input Select button on the remote control or ECP to switch to the correct video source.

If these tasks don't resolve the issue, refer to the following sections for additional troubleshooting information.

Loss of signal

If a video source signal isn't detected, if it's out of range of the projector's support video modes or if the signal is being switched to a different device or input, the projector doesn't show a source signal and instead displays the SMART logo on a blue screen.

To resolve signal loss issues

1. Wait approximately 45 seconds for the image to synchronize. Some video signals require more time to synchronize. Cycling through the inputs can also help image synchronization.
2. If the image doesn't synchronize, check the cable connections to the projector and the ECP.
3. Ensure that the image signal is compatible with the projector (see *Video format* on page 95).
4. If there are any extension cables, switch boxes, connection wall plates or other devices in the video connection from the computer to the projector, temporarily remove them to ensure they aren't causing the video signal loss.
5. If the projector still doesn't show a source signal, contact your authorized SMART reseller.

Partial, scrolling or incorrectly displayed image

NOTE

This procedure may vary depending on the version of Windows® operating system or Mac OS X operating system software and your system preferences. The following procedures apply to Windows 7 operating systems and Mac OS X 10.8 operating system software.

To resolve a partial, scrolling or incorrectly displayed image on a Windows computer

1. Select **Start > Control Panel**.
2. Click **Display**, and then select **Adjust resolution**.
3. Verify that the display resolution is set to 1024 × 768 (SMART U100 projector) or 1280 × 800 (SMART U100w projector in 16:10 aspect ratio mode).
4. Click **Advanced settings**, and then click the **Monitor** tab.
5. Verify that the screen refresh rate is 60 Hz.

To resolve a partial, scrolling or incorrectly displayed image on a Mac computer

1. Select **Apple Menu > System Preferences**.
The *System Preferences* dialog box appears.
2. Click **Displays**.
3. Verify that the display resolution is set to 1024 × 768 (SMART U100) or 1280 × 800 (SMART U100w in 16:10 aspect ratio mode).
4. Verify that the screen refresh rate is 60 Hz.

Unstable or flickering image

If the projector's image is unstable or flickering, the frequency or tracking settings on the input source could be different from the settings on the projector.

IMPORTANT

Write down the current settings before adjusting any of them in the following procedure.

To resolve an unstable or flickering image

1. Check the display mode of your computer's graphics card. Make sure it matches one of the projector's compatible signal formats (see *Video format* on page 95). Refer to your

computer's manual for more information.

2. Configure the display mode of your computer's graphics card to make it compatible with the projector. Refer to your computer's manual for more information.
3. Adjust the frequency, tracking, H-position and V-position settings in the on-screen menu. See *Adjusting projector settings* on page 14.
4. Optionally, reset the projector as described in *Resetting the projector* on page 55 to adjust the frequency and tracking to their original values.



IMPORTANT

This action resets all values to their defaults.

Frozen image

If the projector has a frozen image, perform the following procedure.

To resolve a frozen image

1. Ensure that the Hide Display feature is off.
2. Press the **Hide** button on the projector's remote control to hide or show the display.
3. Ensure that the source device, such as the DVD player or computer, isn't malfunctioning.
4. Put the projector into Standby mode, and then wait 30 minutes for it to cool down.
5. Disconnect the power cable from the power outlet, and then wait at least 60 seconds.
6. Connect the power cable, and then turn on the projector.
7. If the previous steps don't resolve the issue, contact your authorized SMART reseller.

The image doesn't fit the interactive whiteboard

If you're using a SMART U100w projector with a wide screen interactive whiteboard, verify that you're using the correct aspect ratio mode for the interactive whiteboard:

Interactive whiteboard	Aspect ratio mode
SMART Board 885 interactive whiteboard	16:10

You can set the aspect ratio mode using the Native DLP Resolution setting in the Projector Functions menu (see *Adjusting projector settings* on page 14).

The image from a connected laptop computer isn't projected

Laptop computer settings can interfere with projector operations.

Some laptop computers deactivate their screens when you connect a secondary display. Refer to your computer's manual for details on reactivating the computer's display screen.

Unaligned projected image

Alignment errors occur when the projected image isn't perpendicular to the screen. Alignment errors can occur when if the interactive whiteboard system is mounted on an uneven surface or a wall that has obstructions, or if the projector is swiveled too far from the interactive whiteboard's vertical center.

Adjust the projected image using the instructions in the included *SMART Board 800ix3 interactive whiteboard system installation guide* (smarttech.com/kb/170885) and *Adjusting the image* on page 25.

The projector image can slip if the projector is moved often or installed in a location prone to vibration, such as next to a heavy door. Follow these precautions to help prevent the image from becoming unaligned:

- Make sure that the installation wall is plumb and square and doesn't move or vibrate excessively.
- Make sure that there are no obstructions behind the projector's wall-mounting bracket, and that the bracket is firmly secured to the wall according to the installation instructions.
- Adjust the projected image. See the included *SMART Board 800ix3 interactive whiteboard system installation guide* (smarttech.com/kb/170885) and *Adjusting the image* on page 25.

Resolving audio issues

The projector includes an integrated speaker. You can also connect an external audio system to the audio output connector in the projector's connection panel. If sound isn't coming from either the internal speaker or the external audio system, perform the following procedures.

NOTE

You might need to configure your computer to pass audio through HDMI if it isn't configured automatically.

To resolve audio issues

1. Ensure that the speakers' or audio system's cables are properly connected to the audio output plug on the projector's connection panel.

2. Press the **Mute** button on the projector's remote control. If Audio Mute is on, turn it off.
3. Check the ECP's volume knob or use the projector's remote control to ensure that the volume isn't at the lowest setting.
4. Ensure that the speaker or audio system is on and that the volume is turned up.
5. Check that the source input, such as your computer or video device, isn't malfunctioning. Ensure that its audio output is on and that the volume isn't set to the lowest position.



NOTE

You must display the source input's video to play its audio through the connected speakers or audio system.

6. If the previous steps don't resolve the issue, contact your authorized SMART reseller.

Resolving ECP issues

If the ECP isn't receiving power, complete the following tasks:

- Confirm that the ECP cable harness's 11-pin connector is properly connected to the ECP.
- Confirm that the ECP cable harness's 7-pin min-DIN connector is properly connected to the ECP connector on the projector.

Resolving network communication issues

If you don't have network access, perform the following procedure to troubleshoot the system.

To resolve network communication issues

1. Ensure that the network cable is properly connected to the RJ45 connection on the projector's connection panel.
2. Ensure that the LAN warning light on the projector is green. To activate the projector's network features, use the "vgaoutnetenable=on" RS-232 command (see *Projector programming commands* on page 69) or enable the **Network and VGA Out** setting (see *Adjusting projector settings* on page 14). The network features on the projector don't work until you complete one of these tasks.
3. Press the **Menu** button, and then select the **Network Settings** menu to check the IP address. See *Adjusting projector settings* on page 14 for a description of the IP address field. Enter this IP address into your browser or SNMP agent.
4. If you still don't have network access, contact your network administrator. If your administrator is unable to resolve the issue, contact your authorized SMART reseller.

Accessing the service menu

CAUTION

- To prevent tampering or unintentional changes, only system administrators should access the service menu. Do not share the service menu access code with casual users of the interactive whiteboard system.
- Do not adjust any settings in the service menu other than those listed in this guide. Changing other settings can damage or affect the operation of the projector and may invalidate the warranty.

Retrieving your password

If you forget the projector's password, you can retrieve it by accessing the projector service menu directly from the projector or from the password settings menu on the projector's web interface (see *Password settings* on page 64).

To retrieve the password from the service menu

1. Using the remote control, press the following buttons quickly to access the service menu:
Down, Up, Up, Left, Up.
2. Scroll to *Password Get*, and then press **Enter** on the remote control.
The password appears on the screen.
3. Write down the password.
4. Scroll to *Exit*, and then press **Enter** on the remote control to exit the projector service menu.

Resetting the projector

At some point during troubleshooting, you might need to reset all projector settings.



IMPORTANT

This action is irreversible.

To reset all projector settings

1. Using the remote control, press the following buttons quickly to access the service menu:
Down, Up, Up, Left, Up.
2. Scroll to *Factory Reset*, and then press **Enter** on the remote control.
3. Scroll to *Exit*, and then press **Enter** on the remote control to exit the projector service menu.

Transporting the interactive whiteboard system

Save the original interactive whiteboard system packaging so that it's available if you need to transport the interactive whiteboard system. When required, repack it with all of the original packaging. This packaging was designed to provide optimal shock and vibration protection. If you no longer have the original packaging, purchase the same packaging directly from your authorized SMART reseller.

Appendix A

Remotely managing the system through a network interface

Web page management	57
Accessing web page management	58
Home	58
Control panel	58
Control panel II	61
Network settings	62
Email alerts	63
Password settings	64
Simple Network Management Protocol (SNMP)	65

This chapter includes detailed instructions on how to remotely manage the SMART Board interactive whiteboard system settings through a network interface.

Web page management

You can access advanced setup features via the projector's web-based interface. This web page enables you to manage the projector from a remote location using any computer connected to your organization's intranet.

NOTE

To access the web page, use a browser that supports JavaScript. Most commonly used browsers, such as Internet Explorer®, Chrome™ and Firefox®, support JavaScript.

Accessing web page management

Before you can access the web page, connect the projector to the network and enable the projector's network functions using the projector's menu. An IP address appears on the on-screen display.

To use the management web page

1. Start your Internet browser.
2. Type the projector's IP address in the address box, and then press ENTER.
The *SMART U100 Projector Settings* (or *SMART U100w Projector Settings*) window appears.
3. Select the menu options in the left pane to access the settings on each page.
4. Modify settings using your computer's mouse and keyboard, and then click **Submit** or another action button next to each setting you change.

Home

The Home menu page displays basic projector information and enables you to select the on-screen display language.

NOTE

You can view basic projector information but you're unable to change it (with the exception of the on-screen display language) from the Home menu page.



Submenu setting	Description
Language	Displays language options
Projector Information	Displays current projector information



Control panel

This menu enables you to manage the projector audio and video status, alerts and appearance using an Internet browser.

Submenu setting	Description
Power State	Displays the projector's current power state: Idle , Powering , Cooling , or OFF .

Submenu setting	Description
Restore All Projector Defaults	Returns projector settings to default values or refreshes the current settings. Select Submit or Refresh . <div style="background-color: #f0f0f0; padding: 5px; border: 1px solid #ccc;">  IMPORTANT The Submit option is irreversible and resets all values. </div>
Volume	Adjusts the projector's volume from 0 to 40.
Mute	Turns on or turns off the mute settings. Select On to mute the projector's sound and Off to turn off mute.
Volume Control	Enables or disables audio line out.
System Output Switch	Selects the output for the Line input: Line Out+Speaker , Line Out Only , Speaker Only , or none .
Display Mode	Adjusts the display output to SMART Presentation , Bright Room , Dark Room , sRGB and User modes: <ul style="list-style-type: none"> • SMART Presentation is recommended for color fidelity. • Bright Room and Dark Room are recommended for locations with those conditions. • sRGB provides standardized accurate color. • User enables you to apply your own settings.
Brightness	Adjusts projector brightness from 0 to 100.
Contrast	Adjusts the difference between the lightest and darkest parts of the image from 0 to 100.
Frequency	Adjusts the display data frequency of the projected image from -5 to 5 to match the frequency of your computer's graphics card.
Tracking	Synchronizes your projector's display timing with your computer's graphics card from 0 to 63.
White Peaking	Adjusts the image color brightness from 0 to 100 while providing more vibrant white shades. A value closer to 0 creates a natural image and a value closer to 10 increases brightness.
Degamma	Adjusts the color performance of the display from 0 to 31.
Color	Adjusts the Red, Green, Blue, Cyan, Magenta and Yellow colors on the projector from 0 to 100 to provide custom color and luminance output. Each color has a default value of 100. Adjustments to the color settings register to the User mode.
Auto Signal Detect	Enables or disables signal searching of input connectors. <ul style="list-style-type: none"> • When On, the projector continuously switches inputs until it finds an active video source. • When Off, the projector maintains signal detection in one input.

Submenu setting	Description
Lamp Reminder	Select On to show or Off to hide the lamp replacement reminder when it appears. This reminder appears 100 hours before the recommended lamp replacement.
Lamp Mode	Adjusts lamp brightness to Normal or ECO . ECO increases the lamp life by decreasing the image's brightness.
ImageCare	Turns ImageCare on or off.
Auto Power Off	Sets the length of the auto power off countdown timer between 0 and 240 minutes. The timer begins to count down when the projector no longer receives a video signal. The timer finishes when the projector enters Standby mode. Select 0 to turn off the timer. Select 120 to enable proper functioning of ImageCare.
Zoom	Adjusts the zoom to the center of the image in or out from 0 to 30.
H-position (RGB input)	Moves the horizontal position of the source video left or right from 0 to 100 (relative to the projected image). <div data-bbox="685 863 1463 961"> NOTE This is useful in situations where the source video is cut off.</div>
V-position (RGB input)	Moves the vertical position of the source video up or down from -5 to 5 (relative to the projected image). <div data-bbox="685 1052 1463 1150"> NOTE This is useful in situations where the source video is cut off.</div>
Aspect Ratio	Adjusts the image output to Fill Screen , Match Input or 16:9 . <ul style="list-style-type: none">• Fill Screen produces an image that fills the entire screen by stretching and scaling.• Match Input matches the projector's aspect ratio to the input's aspect ratio. As a result, black bands might appear along the top and bottom edges of the screen horizontally (letterbox format) or along the left and right edges of the screen vertically (pillarbox format).• 16:9 changes the output to 16:9 by letterboxing the image, which is recommended for use with HDTV and DVDs enhanced for wide-screen television. <div data-bbox="685 1566 1463 1665"> NOTE See <i>Video format</i> on page 95 for descriptions of each mode.</div>
Startup Screen	Sets the type of startup screen to SMART or User . The SMART screen is the default SMART logo on a blue background. The User screen uses the saved picture from the Capture User Startup Screen function.

Submenu setting	Description
Video Mute	Turns the video mute setting on or off. Select On to hide the display and Off to show it again.
High Speed Fan	Adjusts the speed of the projector's fan. Select High or Normal . <div style="background-color: #f0f0f0; padding: 5px; margin-top: 5px;">  NOTE Use the High setting when the projector's temperature is high or the altitude is above 6000' (1800 m). </div>
Projector Mode	Adjusts the projection mode to Front , Ceiling , Rear or Rear Ceiling . <div style="background-color: #f0f0f0; padding: 5px; margin-top: 5px;">  IMPORTANT SMART recommends that you never change this setting from the Ceiling projection mode. </div>
Source	Adjusts the input source to VGA1 , HDMI1 , HDMI2 , or Composite .
HDMI1	Assigns an alternative name (up to 15 characters long) to the HDMI1 input, which appears when you select the HDMI1 input.
HDMI2	Assigns an alternative name (up to 15 characters long) to the HDMI2 input, which appears when you select the HDMI2 input.
VGA1	Assigns an alternative name (up to 15 characters long) to the VGA1 input, which appears when you select the VGA1 input.
Composite	Assigns an alternative name (up to 15 characters long) to the Composite video input, which appears when you select the Composite video input.
Emergency Alert	Turns the on-screen alert broadcast message on or off. When enabled, this message displays over the current projected image.
Alarm Message	Displays an on-screen emergency notification message (maximum 60 characters).



Control panel II

This menu allows you to associate a video source with a USB receptacle on the ECP or pen tray.

Submenu setting	Description
USB1 Source	Enables touch for the selected video source (VGA , HDMI1 , HDMI2 or None) by associating the video source with the room computer USB receptacle (USB1) on the ECP or pen tray.
USB2 Source	Enables touch for the selected video source (VGA , HDMI1 , HDMI2 or None) by associating the video source with the laptop USB receptacle (USB2) on the ECP or pen tray.

Network settings

This menu allows you to use or not use Dynamic Host Control Protocol (DHCP) and to set the network-related addresses and names when DHCP isn't used.

Submenu setting	Description
DHCP	Determines if the projector's IP address and other network settings are dynamically assigned by a DHCP server or are manually set. <ul style="list-style-type: none">• On allows the network's DHCP server to assign a dynamic IP address to the projector.• Off allows you to manually set the projector's IP address and other network settings.
IP Address	Displays or allows you to set the projector's IP address in values between 0.0.0.0 and 255.255.255.255.
Subnet Mask	Displays or allows you to set the projector's subnet mask number in values between 0.0.0.0 and 255.255.255.255.
Gateway	Displays or allows you to set the projector's default network gateway in values between 0.0.0.0 and 255.255.255.255.
DNS	Displays or allows you to set the projector's IP address for your network's primary domain name server in values between 0.0.0.0 and 255.255.255.255.
Group Name	Displays or allows you to set the projector's workgroup name (maximum 12 characters).
Projector Name	Displays or allows you to set the projector's name (maximum 12 characters).
Location	Displays or allows you to set the projector's location (maximum 16 characters).
Contact	Displays or allows you to set the contact name, number or email address for projector support (maximum 16 characters).
SNMP	Turns the Simple Network Management Protocol (SNMP) agent on or off.
Read-Only Community	Sets a password that is required for each SNMP get request to the device. <div data-bbox="688 1528 1463 1633"> NOTE The default for Read-Only Community is public.</div>
Read/Write Community	Sets a password that is required for each SNMP set request to the device. <div data-bbox="688 1717 1463 1822"> NOTE The default for Read/Write Community is private.</div>

Submenu setting	Description
TRAP Destination Address	Displays or allows you to set the IP address of the network's SNMP TRAP manager in values between 0.0.0.0 and 255.255.255.255. The TRAP destination address is the IP address of the computer assigned to handle unsolicited data generated by SNMP TRAP events generated by the projector, such as power state changes, projector failure modes, a lamp needing to be replaced or other issues.

Email alerts

This menu enables you to enter your preferred address for receiving email alerts and to adjust related settings.

Submenu setting	Description
Email Alert	Select Enable to turn on or Disable to turn off the email alert function.
To	Displays or allows you to set the email address of the email alert recipient.
CC	Displays or allows you to set the email address of the email alert "copy to" recipient.
From	Displays or allows you to set the email address of the user who sends the email alert.
Subject	Displays or allows you to set the email alert subject.
Outgoing SMTP server	Displays or allows you to set the Simple Mail Transfer Protocol (SMTP) server that you use on your network.
Username	Displays or allows you to set the SMTP server user name.
Password	Displays or allows you to set the SMTP server password.

Submenu setting	Description
Alert Condition	<p>Sends email alerts whenever the following conditions occur. Select the settings you want, and then click Submit.</p> <ul style="list-style-type: none">• Lamp Hours Reminder Lh• System Fan 1 Fail F1• System Fan 2 Fail F2• System Fan 3 Fail F3• Blower Fan Fail F4• Lamp Driver (Ballast) failure Fb• System Overheat OH• Famp Failed to Strike LF• Lamp voltage Too High LH• Color Wheel Fail FC• DDP (Processor Failure) FP• 12 VDC Failure PS• DmD Failure Fd• Lamp Driver Overheat dH

 **NOTE**

The projector sends an alert email (SMART Alert) to your email address. Click **Email Alert Test** to confirm that your email address and SMTP server settings are correct by sending a test email (SMART Alert-Test Mail).

If the settings aren't correct, the email alert messages aren't sent or received successfully and warnings and notification message aren't available to advise of this state.

Password settings

This menu provides a security function that allows an administrator to manage projector use and enable the administrator password function.

Submenu setting	Description
Password	When the password function is enabled, the administrator password is required to access Web Management. Select Disable to allow remote web management of the projector without requiring a password.
New Password	Enter a new password
Confirm Password	Confirm the password

 NOTES

- The first time you enable the password settings, the default password value is four numbers, for example, 1234.
- The maximum allowable password length is four numbers or letters.
- If you forget the projector password, refer to *Accessing the service menu* on page 54 to set the projector setting to factory defaults.

Simple Network Management Protocol (SNMP)

The projector supports a list of SNMP commands as described in the management information base (MIB) file. You can download this file by browsing to smarttech.com/software and clicking the MIB file's link in the *Hardware* section for the projector.

The SNMP agent in your projector supports SNMP version 1 or 2. Upload the MIB file to your SNMP management system application, and then use it as described in your application's user guide.

Appendix B

Remotely managing the system through an RS-232 serial interface

Connecting a room control system to the ECP	68
Serial interface settings	68
Projector programming commands	69
Projector power state controls	69
Command/response definitions	69
Field definitions	70
Source Application Selection	70
Command/response definitions	70
Field definitions	71
Video control	72
Command/response definitions	72
Field definitions	74
Audio control	77
Command/response definitions	77
Field definitions	78
Network information	80
Command/response definitions	80
Field definitions	80
System information	81
Command/response definitions	81
Field definitions	84
Service Information	89
Command/response definitions	89
Field definitions	89
Engineering commands	92
Command/response definitions	92
Field definitions	93
Additional commands	94
Command/response definitions	94
Unknown command	94

This appendix includes detailed instructions on how to set up your computer or room control system to remotely manage the SMART Board interactive whiteboard system settings through an RS-232 serial interface.

Connecting a room control system to the ECP

By connecting a computer or room control system to the 4-pin connector on the ECP, you can select video inputs, start up or shut down the interactive whiteboard system and request information such as projector lamp use, current settings and network addresses.

NOTE

On projectors with the RS-232 connector labeled **Control 9v** (rather than **Control**), pin 1 functions as a +9V DC power source only for use with older model ECPs, such as the ones included with SMART UF55 projectors.

Serial interface settings

The projector's serial interface acts as a Data Communications Equipment (DCE) device, and its settings can't be configured. You must configure your computer's serial communication program or the room control system's serial communication settings with the following values:

Setting	Value
Data Rate	19.2 kbps
Data Bits	8
Parity	None
Stop Bits	1
Flow Control	None

NOTES

- Asynchronous mode is disabled by default in the projector.
- All commands should be in ASCII format. Terminate all commands with a carriage return.
- All responses from the projector are terminated with a command prompt. Wait until you receive the command prompt indicating that the system is ready for another command before you proceed.
- The room control feature of the projector is always on.

To configure your computer's serial interface

1. Turn on your computer, and then start your serial communications program or terminal emulation program.
2. Connect your computer to the serial connection cable you previously connected to the control panel.
3. Configure the serial interface settings using the values from the table above, and then press ENTER.

An "invalid cmd= ? for help" message appears, and the ">" character appears as a command prompt on the following line.

IMPORTANT

If no message appears or if an error message appears, the serial interface configuration is not correct. Repeat step 3.

4. Type commands to configure the settings.

NOTES

- To see a list of commands available in the current operating mode, type ? and then press ENTER.
- If you're using a terminal emulation program, turn on your program's local echo setting to see characters as you type them.

Projector programming commands

This section documents the projector programming commands and responses.

Projector power state controls

Use these commands to determine the projector power state and related controls.

Command/response definitions

Command	Response	Responds when powered off
on	powerstate=[power state]	yes
off [off option]	powerstate=[power state]	yes
get powerstate	powerstate=[power state]	yes

Field definitions

Field	Possible values	Description
off option	now	<p>This is an optional field. It forces the projector to shut down. Once this process starts, it can't be canceled. If "now" isn't specified, the "off" command causes a countdown to appear. To turn off the projector, send a second "off" command before the countdown expires; otherwise the projector remains on at the end of the countdown.</p> <div style="background-color: #f0f0f0; padding: 5px; border: 1px solid #ccc;"> <p> NOTE Consider this as another projector state. When the countdown is complete, an asynchronous response indicates that the projector has returned to the "on" state.</p> </div> <p>This command is accepted when the projector has turned off, but it does nothing other than return the power state.</p>
powerstate	<ul style="list-style-type: none"> • powering • on • cooling • confirm off • idle 	<p>The projector's current power state. Different projectors have different potential power states. These power states match the power states in the SMART U100 and SMART U100w projectors.</p>

Source Application Selection

Use these commands to switch among input sources and embedded applications. These commands also control the USB switch for these sources.

Command/response definitions

Command	Response	Responds when powered off
set input [target]	input=[current]	no
get input	input=[current]	yes
get videoinputs	videoinputs=[current]	yes
set usb1source [target]	usb1source=[current]	yes
get usb1source	usb1source=[current]	yes
set usb2source [target]	usb2source=[current]	yes
get usb2source	usb2source=[current]	yes

Field definitions

Field	Possible values	Description
current input	<ul style="list-style-type: none"> • VGA1 • Composite • HDMI1 • HDMI2 • None 	A text list of available video source inputs. None is a non-selectable input and is returned in response to a “get input” command when the projector is turned off.
target input	<ul style="list-style-type: none"> • = VGA1 • = Composite • = HDMI1 • = HDMI2 • = None • = Next 	A text list of possible inputs. Selecting Next causes the projector to move to the next item in the list and return a response equivalent to a user-specified input.
current videoinputs	VGA1, Composite, HDMI1, HDMI2	A comma-separated list of available projector inputs. The strings returned in this command must match the strings used for the input selection from the on-screen display (OSD).
current usb1source	<ul style="list-style-type: none"> • VGA1 • HDMI1 • HDMI2 • Disabled 	Current value for which the USB1 switch is enabled
target usb1source	<ul style="list-style-type: none"> • = VGA1 • = HDMI1 • = HDMI2 • = Disabled 	Value to which the USB1 switch-enabled source is set. If this value is the same as the USB2 source, the USB1 source is used and the USB2 source is ignored.
current usb2source	<ul style="list-style-type: none"> • VGA1 • HDMI1 • HDMI2 • Disabled 	Current value of the USB2 switch
target usb2source	<ul style="list-style-type: none"> • = VGA1 • = HDMI1 • = HDMI2 • = Disabled 	Value to which the USB2 switch-enabled source is set. If this value is the same as the USB2 source, the USB1 source is used and the USB2 source is ignored.

EXAMPLE

```
> set input=vga1
input = vga1
> set input=next
input = composite
> get videoinputs
videoinputs = vga1, composite, hdmi1
> get usb1source
usb1source = vga1
> get usb2source
usb2source = hdmi1
> set usb2source=hdmi1
usb2source = hdmi1
>
```

Video control

Use these commands to change the projector's video output controls. The range of values used for these commands should match the range displayed in the on-screen display (OSD). The firmware must handle videofreeze and videomute states correctly. A change should be made to ensure that videofreeze and videomute are mutually exclusive.

Command/response definitions

Command	Response	Responds when powered off
set displaymode [target]	displaymode=[current]	no
get displaymode	displaymode=[current]	no
set brightness [target]	brightness=[current]	no
get brightness	brightness=[current]	no
set contrast [target]	contrast=[current]	no
get contrast	contrast=[current]	no
set frequency [target]	frequency=[current]	no
get frequency	frequency=[current]	no
set tracking [target]	tracking=[current]	no
get tracking	tracking=[current]	no
set saturation [target]	saturation=[current]	no

get saturation	saturation=[current]	no
set tint [target]	tint=[current]	no
get tint	tint=[current]	no
set sharpness [target]	sharpness=[current]	no
get sharpness	sharpness=[current]	no
set hposition [target]	hposition=[current]	no
get hposition	hposition=[current]	no
set vposition [target]	vposition=[current]	no
get vposition	vposition=[current]	no
set whitepeaking [target]	whitepeaking=[current]	no
get whitepeaking	whitepeaking=[current]	no
set degamma [target]	degamma=[current]	no
get degamma	degamma=[current]	no
set red [target]	red=[current]	no
get red	red=[current]	no
set green [target]	green=[current]	no
get green	green=[current]	no
set blue [target]	blue=[current]	no
get blue	blue=[current]	no
set cyan [target]	cyan=[current]	no
get cyan	cyan=[current]	no
set magenta [target]	magenta=[current]	no
get magenta	magenta=[current]	no
set yellow [target]	yellow=[current]	no
get yellow	yellow=[current]	no
set videofreeze [target]	videofreeze=[current]	no
get videofreeze	videofreeze=[current]	no

set displayhide	displayhide= [target]	no
get displayhide	displayhide= [target]	no

Field definitions

Field	Possible values	Description
target displaymode	<ul style="list-style-type: none"> • = SMART Presentation • = Bright room • = Dark room • = sRGB • = User 	The ranges must match the OSD ranges.
current displaymode	<ul style="list-style-type: none"> • SMART Presentation • Bright room • Dark room • sRGB • User 	The ranges must match the OSD ranges.
target brightness	<ul style="list-style-type: none"> • + val • – val • = 0 to 100 	Use + or – to change the brightness incrementally. Enter a number within the range to set the brightness to a specific level.
current brightness	Range: 0 to 100	The device's current brightness
target contrast	<ul style="list-style-type: none"> • + val • – val • = 0 to 100 	Use + or – to change the contrast incrementally. Enter a number within the range to set the contrast to a specific level.
current contrast	Range: 0 to 100	The device's current contrast
target frequency	<ul style="list-style-type: none"> • + val • – val • = -5 to +5 	The ranges must match the OSD ranges.
current frequency	Range: -5 to +5	The ranges must match the OSD ranges.
target tracking	<ul style="list-style-type: none"> • + val • – val • = 0 to 31 	The ranges must match the OSD ranges.
current tracking	Range: 0 to 31	The ranges must match the OSD ranges.

APPENDIX B
REMOTELY MANAGING THE SYSTEM THROUGH AN RS-232 SERIAL INTERFACE

Field	Possible values	Description
target saturation	<ul style="list-style-type: none"> • + val • - val • = 0 to 100 	The ranges must match the OSD ranges.
current saturation	Range: 0 to 100	The ranges must match the OSD ranges.
target tint	<ul style="list-style-type: none"> • + val • - val • = 0 to 100 	The ranges must match the OSD ranges.
current tint	Range: 0 to 100	The ranges must match the OSD ranges.
target sharpness	<ul style="list-style-type: none"> • + val • - val • = 0 to 31 	The ranges must match the OSD ranges.
current sharpness	Range: 0 to 31	The ranges must match the OSD ranges.
target hposition	<ul style="list-style-type: none"> • + val • - val • = 0 to 100 	The ranges must match the OSD ranges.
current hposition	Range: 0 to 100	The ranges must match the OSD ranges.
target vposition	<ul style="list-style-type: none"> • + val • - val • = -5 to +5 	The ranges must match the OSD ranges. Values depend upon the source.
current vposition	Range: -5 to +5	The ranges must match the OSD ranges.
target whitepeaking	<ul style="list-style-type: none"> • + val • - val • = 0 to 10 	The ranges must match the OSD ranges.
current whitepeaking	Range: 0 to 10	The ranges must match the OSD ranges.
target degamma	<ul style="list-style-type: none"> • + val • - val • = 0 to 3 	The ranges must match the OSD ranges.
current degamma	Range: 0 to 3	The ranges must match the OSD ranges.
target red	<ul style="list-style-type: none"> • + val • - val • = 0 to 100 	The ranges must match the OSD ranges.
current red	Range: 0 to 100	The ranges must match the OSD ranges.

APPENDIX B
REMOTELY MANAGING THE SYSTEM THROUGH AN RS-232 SERIAL INTERFACE

Field	Possible values	Description
target green	<ul style="list-style-type: none"> • + val • - val • = 0 to 100 	The ranges must match the OSD ranges.
current green	Range: 0 to 100	The ranges must match the OSD ranges.
target blue	<ul style="list-style-type: none"> • + val • - val • = 0 to 100 	The ranges must match the OSD ranges.
current blue	Range: 0 to 100	The ranges must match the OSD ranges.
target cyan	<ul style="list-style-type: none"> • + val • - val • = 0 to 100 	The ranges must match the OSD ranges.
current cyan	Range: 0 to 100	The ranges must match the OSD ranges.
target magenta	<ul style="list-style-type: none"> • + val • - val • = 0 to 100 	The ranges must match the OSD ranges.
current magenta	Range: 0 to 100	The ranges must match the OSD ranges.
target yellow	<ul style="list-style-type: none"> • + val • - val • = 0 to 100 	The ranges must match the OSD ranges.
current yellow	Range: 0 to 100	The ranges must match the OSD ranges.
target videofreeze	<ul style="list-style-type: none"> • = on • = off 	Video freeze on/off
current videofreeze	<ul style="list-style-type: none"> • = on • = off 	Video freeze on/off
current displayhide	<ul style="list-style-type: none"> • normal • frozen • muted 	Matches the three states of the Hide button on the remote control.
target displayhide	<ul style="list-style-type: none"> • normal • frozen • muted • next 	Set the mode directly or move from one state to the next sequentially.

Use the above commands to set the property to an absolute value or to adjust the current value.

EXAMPLE

```
>get brightness  
brightness=55  
>set brightness = 65  
brightness=65  
>set brightness +5  
brightness=70  
>set brightness -15  
brightness=55  
>
```

All video commands also have an optional source specification. For example, to set the brightness of a specific source, use the following command.

EXAMPLE

```
>set brightness = 65  
brightness=65  
>set brightness vga1 = 65  
brightness vga1 = 65
```

This sets the brightness of the VGA1 source whether the projector is on this source or not.

Audio control

Use these commands to set audio output controls. The range of values used for these commands should match the range shown in the on-screen display (OSD).

Command/response definitions

Command	Response	Powered off
set volume [target]	volume=[current]	no
get volume	volume=[current]	no
set micvolume [target]	micvolume=[current]	no
get micvolume	micvolume=[current]	no
set mute [target]	mute=[current]	no
get mute	mute=[current]	no

APPENDIX B
REMOTELY MANAGING THE SYSTEM THROUGH AN RS-232 SERIAL INTERFACE

Command	Response	Powered off
set volumecontrol [target]	volumecontrol= [current]	no
get volumecontrol	volumecontrol= [current]	no
set cc [target]	cc=[current]	no
get cc	cc=[current]	no
set sysoutputsw [target]	sysoutputsw=[current]	no
get sysoutputsw	sysoutputsw=[current]	no

Field definitions

Field	Possible values	Description
target volume	<ul style="list-style-type: none"> • + val • – val • = -20 to 20 	Use + or – to change the volume incrementally. Enter a number within the range to set the volume to a specific level. When you modify the volume using the RS-232, the OSD's volume slider matches the slider that appears when you use another control. Note that -20 should map to 0 and 20 should map to 40.
current volume	Range: -20 to 20	The device's current volume. Note that -20 should map to 0 and 20 should map to 40.
target micvolume	<ul style="list-style-type: none"> • + val • – val • = -20 to 20 	Use + or – to change the micvolume incrementally. Enter a number within the range to set the volume to a specific level. When you modify the volume using the RS-232, the OSD's volume slider matches the slider that appears when you use another control. Note that -20 should map to 0 and 20 should map to 40.
current micvolume	Range: -20 to 20	The device's current volume.
target mute	<ul style="list-style-type: none"> • = on • = off 	Specifies whether mute is enabled or disabled.
current mute	<ul style="list-style-type: none"> • = on • = off 	Current state of the mute function

APPENDIX B
REMOTEY MANAGING THE SYSTEM THROUGH AN RS-232 SERIAL INTERFACE

Field	Possible values	Description
current volumecontrol	<ul style="list-style-type: none">• = on• = off	Current state of the volume control
target volumecontrol	<ul style="list-style-type: none">• = on• = off	Specifies whether volume control is enabled or disabled.
target cc	<ul style="list-style-type: none">• = cc1• = cc2• = off	Closed captioning states
current cc	<ul style="list-style-type: none">• = cc1• = cc2• = off	Closed captioning states
target sysoutputsw	<ul style="list-style-type: none">• = line+spkr• = line• = spkr• = none	Specifies the system output switch
current sysoutputsw	<ul style="list-style-type: none">• = line+spkr• = line• = spkr• = none	Current state of the system output switch

Use the commands above to set the property to an absolute value or to adjust the current value.

EXAMPLE

```
>get volume
volume=0
>set volume=-10
volume=-10
>set volume +5
volume=-5
>set volume -15
volume=-20
```

Network information

Use these commands to set your network information.

Command/response definitions

Command	Response	Powered off
get netstatus	netstatus=[current]	yes
set network	network=[current]	yes
get network	network=[current]	yes
set dhcp [target]	dhcp=[current]	yes
get dhcp	dhcp=[current]	yes
set ipaddr [target]	ipaddr=[current]	yes
get ipaddr	ipaddr=[current]	yes
set subnetmask [target]	subnetmask=[current]	yes
get subnetmask	subnetmask=[current]	yes
set gateway [target]	gateway=[current]	yes
get gateway	gateway=[current]	yes
set primarydns [target]	primarydns=[current]	yes
get primarydns	primarydns=[current]	yes
get macaddr	macaddr=[MAC address]	yes

Field definitions

Field	Possible values	Description
current netstatus	<ul style="list-style-type: none">connecteddisconnected	Current status of the network interface
current network	<ul style="list-style-type: none">onoff	Current status of the network module and the VGA output
target network	<ul style="list-style-type: none">onoff	Enable/Disable network module and VGA output

Field	Possible values	Description
current dhcp	<ul style="list-style-type: none"> • = on • = off 	Enable/Disable for DHCP Networking
target dhcp	<ul style="list-style-type: none"> • on • off 	Enable/Disable for DHCP Networking
current ipaddr	Range: 0.0.0.0 to 255.255.255.255	Current IP address (static or dhcp assigned)
target ipaddr	= Range: 0.0.0.0 to 255.255.255.255	Set to static IP Address
current subnetmask	Range: 0.0.0.0 to 255.255.255.255	Current subnet Mask
target subnetmask	= Range: 0.0.0.0 to 255.255.255.255	Target subnet Mask
current gateway	Range: 0.0.0.0 to 255.255.255.255	Current gateway
target gateway	= Range: 0.0.0.0 to 255.255.255.255	Target gateway
current primarydns	Range: 0.0.0.0 to 255.255.255.255	Current primary dns
target primarydns	= Range: 0.0.0.0 to 255.255.255.255	Target primary dns
MAC address	xx-xx-xx-xx-xx-xx	The device's MAC address.

System information

Use these commands to set the system information.

Command/response definitions

Command	Response	Powered off
set autosignal [target]	autosignal=[current]	no
get autosignal	autosignal=[current]	no
set lampreminder [target]	lampreminder=[current]	no
get lampreminder	lampreminder=[current]	no

APPENDIX B
REMOTELY MANAGING THE SYSTEM THROUGH AN RS-232 SERIAL INTERFACE

Command	Response	Powered off
set lampmode [target]	lampmode=[current]	no
get lampmode	lampmode=[current]	no
set ImageCare [target]	ImageCare=[current]	no
get ImageCare	ImageCare=[current]	no
set autopoweroff [target]	autopoweroff=[current]	no
get autopoweroff set zoom [target]	autopoweroff=[current]	no
set zoom [target]	zoom=[current]	no
get zoom	zoom=[current]	no
set projectorid [target]	projectorid=[current]	no
get projectorid	projectorid=[current]	no
set aspectratio [target]	aspectratio=[current]	no
get aspectratio	aspectratio=[current]	no
set projectionmode [target]	projectionmode=[current]	no
get projectionmode	projectionmode=[current]	no
set startupscreen [target]	startupscreen=[current]	no
get startupscreen	startupscreen=[current]	no
set restoredefaults	restoredefaults=[current]	yes
get lamphrs	lamphrs=[current]	yes
set lamphrs [target]	lamphrs=0	yes
get syshrs	syshrs=[current]	yes
get resolution	resolution=[current]	no
get nativeaspectratio	nativeaspect=[native]	no
get fwverddp	fwverddp=[current]	yes
get fwvernet	fwvernet=[current]	yes
get fwvermpu	fwvermpu=[current]	yes

APPENDIX B
REMOTELY MANAGING THE SYSTEM THROUGH AN RS-232 SERIAL INTERFACE

Command	Response	Powered off
get serialnum	serialnum=[current]	yes
get fwverecp	fwverecp=[current]	yes
set language [target]	language=[current]	no
get language	language=[current]	no
set groupname [target]	groupname=[current]	no
get groupname	groupname=[current]	no
set projectorname [target]	projectorname=[current]	no
get projectorname	projectorname=[current]	no
set locationinfo [target]	locationinfo=[current]	no
get locationinfo	locationinfo=[current]	no
set contactinfo [target]	contactinfo=[current]	no
get contactinfo	contactinfo=[current]	no
get modelnum	modelnum=U100, or modelnum=U100w	no Returns the actual model of the projector
set videomute [target]	videomute=[current]	no
get videomute	videomute=[current]	no
set vgaoutnetenable [target]	vgaoutnetenable=[current]	yes
get vgaoutnetenable	vgaoutnetenable=[current]	yes
set emergencyalertmsg [target]	emergencyalertmsg=[current]	no
get emergencyalertmsg	emergencyalertmsg=[current]	no
set emergencyalert [target]	emergencyalert=[current]	no
get emergencyalert	emergencyalert=[current]	no
get signaldetected	signaldetected=[current]	yes The response varies depending on the power mode.

Field definitions

Field	Possible values	Description
target autosignal	<ul style="list-style-type: none"> • = on • = off 	The ranges must match the OSD settings.
current autosignal	<ul style="list-style-type: none"> • on • off 	The ranges must match the OSD settings.
target lampreminder	<ul style="list-style-type: none"> • = on • = off 	The ranges must match the OSD settings.
current lampreminder	<ul style="list-style-type: none"> • on • off 	The ranges must match the OSD settings.
target lampmode	<ul style="list-style-type: none"> • = standard • = ECO 	The ranges must match the OSD settings.
current lampmode	<ul style="list-style-type: none"> • standard • ECO 	The ranges must match the OSD settings.
target ImageCare	<ul style="list-style-type: none"> • = on • = off 	The ranges must match the OSD settings.
current ImageCare	<ul style="list-style-type: none"> • on • off 	The ranges must match the OSD settings.
target autopoweroff	<ul style="list-style-type: none"> • + val • – val • = 0 to 240 	The ranges must match the OSD ranges.
current autopoweroff	<ul style="list-style-type: none"> • + val • – val • = 0 to 240 	The ranges must match the OSD ranges.
target zoom	<ul style="list-style-type: none"> • + val • – val • = 0 to 30 	The ranges must match the OSD ranges.
current zoom	<ul style="list-style-type: none"> • = 0 to 30 	The ranges must match the OSD ranges.
target projectorid	<ul style="list-style-type: none"> • + val • – val • = 0 to 999 	The ranges must match the OSD ranges.

Field	Possible values	Description
current projectorid	<ul style="list-style-type: none"> • = 0 to 999 	The ranges must match the OSD ranges.
target aspectratio	<ul style="list-style-type: none"> • = fill • = match • = 16:9 	<p>The ranges must match the OSD ranges.</p> <p>Fill: Regardless of the input, the image is stretched to match the DMD device. For example, a 16:9 image appears as a 4:3 image on an XGA projector and as a 16:10 image on a WXGA projector.</p> <p>Match: The signal is scaled so that the input aspect ratio is maintained. For example, a 4:3 image appears as a 4:3 image on screen.</p> <p>16:9 The signal is scaled and stretched to produce a 16:9 image.</p>
current aspectratio	<ul style="list-style-type: none"> • fill • match • 16:9 	The ranges must match the OSD settings.
target projectionmode	<ul style="list-style-type: none"> • = front • = ceiling • = rear • = rear ceiling 	The ranges must match the OSD settings.
current projectionmode	<ul style="list-style-type: none"> • = front • = ceiling • = rear • = rear ceiling 	The ranges must match the OSD settings.
target startupscreen	<ul style="list-style-type: none"> • = smart • = usercapture • = preview 	The ranges must match the OSD settings.
current startupscreen	<ul style="list-style-type: none"> • = smart • = usercapture • = preview 	The ranges must match the OSD settings.

REMOTELY MANAGING THE SYSTEM THROUGH AN RS-232 SERIAL INTERFACE

Field	Possible values	Description
current reset	<ul style="list-style-type: none"> done 	Sent once you reset the projector.
current lamphrs	<ul style="list-style-type: none"> 0 to 5000 	Current lamp hour usage
target lamphrs	0	Clear the current lamp hour usage. The only valid value is 0.
current resolution	<ul style="list-style-type: none"> 800x600 1024x768 ... no signal 	Current resolution of the input. If no signal is detected, "resolution=no signal" appears.
native aspect ratio	4:3 for SMART U100, 16:10 for SMART U100w	Native aspect ratio. DLP resolution of the projector. Returns the actual native aspect ratio of the projector.
current fwverddp	x.x.x.x	Firmware version
current fwvernet	x.x.x.x	Network processor version
current fwvermpu	x.x.x.x	MPU version
current prjserialnum	xxxxxxxxxxxx	Projector serial number
current fwverecp	x.x.x.x	ECP version, if present

Field	Possible values	Description
current language	<ul style="list-style-type: none"> • English (US) • English (U.K.) • French (France) • German • Dutch • Danish • Finnish • Italian • Norwegian • Russian • Spanish • Swedish • Portugese • Chinese (Simplified) • Chinese (Traditional) • Czech • Hungarian • Japanese • Malayasian • Polish • Romanian • Arabic • Turkish • Greek • Slovak • Korean • Hebrew 	Must match the OSD setting
target language	= above	Must match the OSD setting.
target groupname	= user string	
current groupname	user string	
target projectname	= user string	

REMOTEY MANAGING THE SYSTEM THROUGH AN RS-232 SERIAL INTERFACE

Field	Possible values	Description
current projectorname	user string	
target locationinfo	= user string	
current locationinfo	user string	
target contactinfo	= user string	
current contactinfo	user string	
current modelnum	user string	Must match the OSD setting
current videomute	<ul style="list-style-type: none"> • on • off 	Must match the OSD setting.
target videomute	<ul style="list-style-type: none"> • = on • = off 	Must match the OSD setting.
current vgaoutnetenable	<ul style="list-style-type: none"> • on • off 	Status of VGA Out Enable and Network Enable
target vgaoutnetenable	<ul style="list-style-type: none"> • = on • = off 	Value for VGA Out and Network Enable
current emergencyalertmsg	User string	Emergency Alert message
target emergencyalertmsg	= User string	Set the Emergency Alert message
current emergencyalert	<ul style="list-style-type: none"> • on • off 	To display the alert message, set this value to "on."
target emergencyalertmsg	<ul style="list-style-type: none"> • = on • = off 	If the message is being displayed, "on" is returned.
current signaldetected	<ul style="list-style-type: none"> • true • false 	If a signal is detected, "true" is returned.
Command List	A list of commands appears. This list doesn't include service information commands.

Service Information

These commands are used in servicing and manufacturing the projector. They are hidden from the user during normal operation.

Command/response definitions

Command	Response	Powered off
get displayhour	displayhour=[current]	no
set testpattern [target]	testpattern=[current]	no
set colorwheelidx [target]	colorwheelidx=[current]	no
get colorwheelidx	colorwheelidx=[current]	no
get failurelog	failurelog=[current]	yes
get error#	error#=[current]	yes
set factoryreset [target]	factoryreset=[current]	yes
set highspeedfan [target]	highspeedfan=[current]	no
get highspeedfan	highspeedfan=[current]	no
set statereporting [target]	statereporting=[current]	yes
get statereporting	statereporting=[current]	yes
get poweroverride	poweroverride=[current]	no
set poweroverride [target]	poweroverride=[current]	no

Field definitions

Field	Possible Values	Description
current displayhour	0 to 20000	Current display hours.
target testpattern	= 1 to 4	Set the test pattern to pattern number (1 to 4). If there's only one test pattern, call it test pattern 1.

Field	Possible Values	Description
current testpattern	<ul style="list-style-type: none">• 1: 19 × 25 Grid• 2: Red• 3: Green• 4: Blue• 5: Grey• 6: White• 7: Black	Test pattern being displayed. The built-in test pattern can be changed.
target colorwheelidx	= ???	The ranges must match the OSD ranges.
current colorwheelidx	???	The ranges must match the OSD ranges.

Field	Possible Values	Description
current failurelog	<ul style="list-style-type: none"> • Normal (NO) • Lamp Failed to Strike (LS) • Lamp Failed (LF) • Lamp Hours Reminder (Lh) • Lamp Voltage Too High (LH) • System Fan 1 Fail (F1) • System Fan 2 Fail (F2) • System Fan 3 Fail (F3) • Rear Blower Fan Fail (F4) • Front Blower Fan Fail (F5) • Colour Wheel Fail (FC) • 12 VDC Failure (PS) • DDP Processor Failure (FP) • DmD Failure (Fd) • Lamp Driver failure (Fb) • Lamp Driver Overheat (dH) • System Overheat (OH) 	<p>Projector's error state. The modes are projector dependent.</p> <p>When get failurelog is used, the abbreviated version of the error state (in parenthesis) is retrieved.</p> <p>When get error# is used, the full name of the error is retrieved.</p>
Current error#	<p>Provide the details of the specific error. “#” is the number recorded in the log. It ranges from 1 to 5. 1 indicates the most recent error and 5 indicates the oldest error.</p>	<p>The details include the failure reason, system hours, lamp hours, sensor temperature and lamp voltage.</p> <p>Example:</p> <p>error1=Rear Blower Fan Fail F4, syshrs:1000, lamphrs=1000, temp=60,volt=120.</p> <p>error2= System Overheat OH, syshrs:3000, lamphrs=2900, temp=150,volt=120.</p>

Field	Possible Values	Description
target factoryreset	<ul style="list-style-type: none"> • = true • = false 	If set to “true,” perform a factory reset. Otherwise, do nothing.
current factoryreset	<ul style="list-style-type: none"> • = true • = false 	Set to “true” only if a factory reset is about to occur.
target highsppedfan	<ul style="list-style-type: none"> • = high • = normal 	Must match the OSD settings.
current highsppedfan	<ul style="list-style-type: none"> • high • normal 	Must match the OSD settings.
current statereporting	<ul style="list-style-type: none"> • on • off 	Current state reporting value
target statereporting	<ul style="list-style-type: none"> • = on • = off 	Target state reporting value
current poweroverride	<ul style="list-style-type: none"> • on • off 	<p>A power override forces the projector to remain on when the command is received. This command isn’t persistent and isn’t stored to non-volatile memory (cleared on power cycle). When this mode is enabled, the power button on the remote control and the ECP, if present, must not turn off the projector.</p> <p>This command must also be added to the service menu so the user can disable it from the OSD.</p>
target poweroverride	<ul style="list-style-type: none"> • = on • = off 	Sets the power override

Engineering commands

These commands are to be part of the RS232 list but not viewable by the “?” command

Command/response definitions

Command	Response	Powered off
set dbmsgon [target]	dbmsgon =[current]	no

REMOTEY MANAGING THE SYSTEM THROUGH AN RS-232 SERIAL INTERFACE

Command	Response	Powered off
get vgalibration	vgalibration = [current]	no
get waveformid	waveformid=[current]	no
get lampvoltage	lampvoltage =[current]	no
get temperature	temperature =[current]	no
set temperaturereport [target]	temperaturereport= [current]	no
set downloadlampdriver [target]	downloadlampdriver= [current]	no
clearfailurelog		no
set burnin		no
dwscaler#7537		no

Field definitions

Field	Possible Values	Description
target dbmsg	<ul style="list-style-type: none"> • on • off 	Turn on/off debug message.
current vgalibration	<ul style="list-style-type: none"> • ??? 	To get the status of ADC calibration while power on.
current waveformid	<ul style="list-style-type: none"> • ??? 	To get waveform ID while power on.
current lampvoltage	<ul style="list-style-type: none"> • ??? 	To get lamp voltage while power on.
current temperature	<ul style="list-style-type: none"> • ??? 	To get system temperature while power on.
target temperaturereport	<ul style="list-style-type: none"> • on • off 	While set to on, the system temperature is sent every five seconds (requires high-speed fan mode to be on)
target downloadlampdriver	<ul style="list-style-type: none"> • done 	Auto program waveform while standby
clearfailurelog	<ul style="list-style-type: none"> • done 	Clear all failure log for production burn in preparation.
dwscaler#7537		Enter DDP download mode

Additional commands

These commands and behaviors are to provide backward compatibility for legacy control interfaces.

Command/response definitions

Command	Execute command:	Behaviour
set input=VGA1	set input=VGA1	switch to VGA1 port
set input=Composite	set input=NEXT	switch to next physical port
set input=HDMI1	set input=NEXT	switch to next physical port
set input=HDMI2	set input=NEXT	switch to next physical port

Unknown command

If an unknown command is received, the projector sends the following response to the user (there is a space between “invalid” and “cmd”).

```
>dummycommand 2134  
invalid cmd=dummycommand 2134
```

Appendix C

Integrating other devices

Video format	95
Native Video Format	95
Video format compatibility	96
SMART U100 projector	96
SMART U100w projector	97
HD and SD signal format compatibility	99
SMART U100 projector	99
SMART U100w projector	99
Video system signal compatibility	100
SMART U100 projector	100
SMART U100w projector	100
Connecting peripheral sources and outputs	101

This appendix provides information on integrating the SMART Board interactive whiteboard system with peripheral devices.

Video format

The projector has a native video format and various video format compatibility modes. You can change image appearances for certain formats and compatibilities.

Native Video Format

The following table lists the native VESA RGB video formats for the projector.

Projector	Resolution	Mode	Aspect ratio	Refresh rate (Hz)	Horizontal frequency (kHz)	Pixel clock (MHz)
SMART U100	1024 × 768	XGA	4:3	60	48	65
SMART U100w	1280 × 800	WXGA	16:10	60	48	65

Video format compatibility

The following tables list the projectors' compatible VESA RGB video formats by resolution, which the projector adjusts automatically when you use the aspect ratio commands described in *Adjusting projector settings* on page 14.

SMART U100 projector

Resolution	Mode	Aspect ratio	Refresh rate (Hz)	Match Input appearance
720 × 400	720×400_85	1.8:1	85.039	Letterbox
640 × 480	VGA 60	4:3	59.94	Full screen
640 × 480	VGA 72	4:3	72.809	Full screen
640 × 480	VGA 75	4:3	75	Full screen
640 × 480	VGA 85	4:3	85.008	Full screen
800 × 600	SVGA 56	4:3	56.25	Full screen
800 × 600	SVGA 60	4:3	60.317	Full screen
800 × 600	SVGA 72	4:3	72.188	Full screen
800 × 600	SVGA 75	4:3	75	Full screen
800 × 600	SVGA 85	4:3	85.061	Full screen
832 × 624	MAC 16"	4:3	74.55	Full screen
1024 × 768	XGA 60	4:3	60.004	Full screen
1024 × 768	XGA 70	4:3	70.069	Full screen
1024 × 768	XGA 75	4:3	75.029	Full screen
1024 × 768	XGA 85	4:3	84.997	Full screen
1024 × 768	MAC 19"	4:3	74.7	Full screen
1152 × 864	SXGA1 75	4:3	75	Full screen
1280 × 720	HD 720	16:9	60	Letterbox
1280 × 768	SXGA1 75	1.67:1	60	Letterbox
1280 × 800	WXGA	16:10	60	Letterbox
1280 × 960	Quad VGA 60	4:3	60	Full screen
1280 × 960	Quad VGA 85	4:3	85.002	Full screen
1280 × 1024	SXGA3 60	5:4	60.02	Letterbox
1280 × 1024	SXGA3 75	5:4	75.025	Letterbox

APPENDIX C
INTEGRATING OTHER DEVICES

Resolution	Mode	Aspect ratio	Refresh rate (Hz)	Match Input appearance
1280 × 1024	SXGA3 85	5:4	85.024	Letterbox
1360 × 765	1.04M9	16:9	59.799	Letterbox
1600 × 900	1.44M9	16:9	59.946	Letterbox
1600 × 1200	UXGA	4:3	60	Full screen
1680 × 1050	1680x1050 50	16:10	49.974	Letterbox
1680 × 1050	1680x1050 50	16:10	59.954	Letterbox
1920 × 1080	HD 1080	16:9	60	Letterbox

SMART U100w projector

Resolution	Mode	Aspect ratio	Refresh rate (Hz)	Match Input appearance (16:10 aspect ratio mode)	Match Input appearance (16:9 aspect ratio mode)
720 × 400	720x400_85	9:5	85.039	Letterbox	Letterbox
640 × 480	VGA 60	4:3	59.94	Pillarbox	Pillarbox
800 × 600	VGA 72	4:3	72.809	Pillarbox	Pillarbox
800 × 600	VGA 75	4:3	75	Pillarbox	Pillarbox
800 × 600	VGA 85	4:3	85.008	Pillarbox	Pillarbox
800 × 600	SVGA 56	4:3	56.25	Pillarbox	Pillarbox
800 × 600	SVGA 60	4:3	60.317	Pillarbox	Pillarbox
800 × 600	SVGA 72	4:3	72.188	Pillarbox	Pillarbox
800 × 600	SVGA 75	4:3	75	Pillarbox	Pillarbox
800 × 600	SVGA 85	4:3	85.061	Pillarbox	Pillarbox
832 × 624	MAC 16"	4:3	74.55	Pillarbox	Pillarbox
1024 × 768	XGA 60	4:3	60.004	Pillarbox	Pillarbox
1024 × 768	XGA 70	4:3	70.069	Pillarbox	Pillarbox
1024 × 768	XGA 75	4:3	75.029	Pillarbox	Pillarbox
1024 × 768	XGA 85	4:3	84.997	Pillarbox	Pillarbox
1024 × 768	MAC 19"	4:3	74.7	Pillarbox	Pillarbox

APPENDIX C
INTEGRATING OTHER DEVICES

Resolution	Mode	Aspect ratio	Refresh rate (Hz)	Match Input appearance (16:10 aspect ratio mode)	Match Input appearance (16:9 aspect ratio mode)
1152 × 864	SXGA 75	4:3	75	Pillarbox	Pillarbox
1280 × 768	WXGA 60	1.67:1	60	Letterbox	Pillarbox
1280 × 960	Quad VGA 60	4:3	60	Pillarbox	Pillarbox
1280 × 960	Quad VGA 85	4:3	85.002	Pillarbox	Pillarbox
1280 × 960	SXGA3 60	5:4	60.02	Pillarbox	Pillarbox
1280 × 1024	SXGA3 75	5:4	75.025	Pillarbox	Pillarbox
1600 × 1200	SXGA+	4:3	59.978	Pillarbox	Pillarbox
1600 × 1200	UXGA_60	4:3	60	Pillarbox	Pillarbox

HD and SD signal format compatibility

The following tables list the projectors' high definition (HD) and standard definition (SD) format signal compatibility, which the projector adjusts automatically when you use the aspect ratio commands described in *Adjusting projector settings* on page 14.

SMART U100 projector

Signal format	Aspect ratio	Horizontal frequency (kHz)	Vertical frequency (Hz)	Match Input appearance
480i (DVD player) (640 × 480)	4:3	15.73	59.94	Full screen
567i (DVD player) (720 × 576)	5:4	15.63	50	Letterbox
720p	16:9	44.96	59.94	Letterbox
720p	16:9	35	50	Letterbox
1080i	16:9	33.7	59.94	Letterbox
1080i	16:9	28.1	50	Letterbox

SMART U100w projector

Signal format	Aspect ratio	Horizontal frequency (kHz)	Vertical frequency (Hz)	Match Input appearance (16:10 aspect ratio mode)	Match Input appearance (16:9 aspect ratio mode)
480i (525i)	4:3	15.73	59.94	Pillarbox	Pillarbox
480p (525p)	4:3	31.47	59.94	Pillarbox	Pillarbox
576i (625i)	5:4	15.63	50	Pillarbox	Pillarbox
576p (625p)	5:4	31.25	50	Pillarbox	Pillarbox
720p (750p)	16:9	45	59.94	Letterbox	Full screen
720p (750p)	16:9	37.5	50	Letterbox	Full screen
1080i (1125i)	16:9	33.75	59.94	Letterbox	Full screen
1080i (1125i)	16:9	28.13	50	Letterbox	Full screen
1080p (1125p)	16:9	67.5	59.94	Letterbox	Full screen
1080p (1125p)	16:9	56.25	50	Letterbox	Full screen

 **NOTE**

The projector is HD-ready. Its native resolution supports a pixel-perfect display of 720p source content. However, because the projector compresses 1080p source content to fit its native resolution, it doesn't support a pixel-perfect display of 1080p source content.

Video system signal compatibility

The following tables list the projectors' video system signal compatibility, particularly for signals delivered over Composite video connectors, which the projector adjusts automatically when you use the aspect ratio commands described in *Adjusting projector settings* on page 14.

 **NOTE**

The 16:9 command delivers all video modes with black bands along the top and bottom edges of the screen. The Match Input command might deliver video modes with black bands along the top and bottom edges of the screen, depending on the input resolution.

SMART U100 projector

Video mode	Aspect ratio	Horizontal frequency (kHz)	Vertical frequency (Hz)	Color signal (MHz)
NTSC	4:3	15.73	29.96	3.58
PAL	4:3	15.62	25	4.43
SECAM	4:3	15.62	25	4.25 (f _{ob}) 4.06 (f _{or})

SMART U100w projector

Video mode	Aspect ratio	Horizontal frequency (kHz)	Vertical frequency (Hz)	Color signal (MHz)
NTSC	4:3	15.73	59.94	3.58
PAL	4:3	15.63	50	4.43
SECAM	4:3	15.63	50	4.25 and 4.41
PAL-M	4:3	15.73	59.94	3.58
PAL-N	4:3	15.63	50	3.58
PAL-60	4:3	15.73	59.94	4.43
NTSC 4.43	4:3	15.73	59.94	4.43

Connecting peripheral sources and outputs

Follow these instructions if you have a peripheral device to connect to the interactive whiteboard system.



NOTES

- Measure the distance between the projector and the peripheral device you want to connect. Make sure each cable has enough slack to be placed safely in your room without presenting a trip hazard.
- Do not disconnect cables from the ECP to connect peripheral devices because you could disconnect controls for your interactive whiteboard.
- Do not connect SBA-L projection audio system speakers to the RCA connector pod. Connect these speakers to the projector connection panel using a dual-channel (left and right) RCA plug-to-3.5 mm phone connector (included with the speakers).
- The composite video connector and associated dual channel audio inputs on the projector and optional RCA connector pod are for input only. These RCA jacks don't provide an output signal.

To connect a laptop to a SMART Board interactive whiteboard system

1. Connect a USB cable from the laptop computer to the ECP.
2. Connect a VGA cable from the laptop computer to the VGA connection kit.

OR

Connect an HDMI cable from the laptop computer to the projector.



TIP

Alternatively you can use a DVI-D-to-HDMI cable.

 **To connect a DVD/Blu-ray player or similar device**

1. If speakers are installed, turn the volume dial on the ECP all the way down to prevent buzzing or popping.
2. Press the **Input** button on the ECP or remote control to switch input sources to the peripheral device.
3. Restore the volume on the ECP's volume dial.

 **NOTE**

HDMI inputs are High Definition Content Protection (HDCP) compliant.

Appendix D

Remote control code definitions

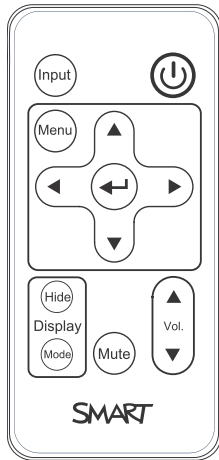

IR signal format: NEC1

Key	Repeat format	Vendor code		Key code	
		Byte 1	Byte 2	Byte 3	Byte 4
Input	F1	8B	CA	14	EB
Power (⏻)	F1	8B	CA	12	ED
Menu	F1	8B	CA	1B	E4
Up (▲)	F1	8B	CA	40	BF
Left (◀)	F1	8B	CA	42	BD
Enter (↵)	F1	8B	CA	13	EC
Right (▶)	F1	8B	CA	43	BC
Down (▼)	F1	8B	CA	41	BE
Hide	F1	8B	CA	15	EA
Volume up (▲)	F1	8B	CA	44	BB
Mode	F1	8B	CA	45	BA
Mute	F1	8B	CA	11	EE
Volume down (▼)	F1	8B	CA	46	B9

Appendix E

Hardware environmental compliance

SMART Technologies supports global efforts to ensure that electronic equipment is manufactured, sold and disposed of in a safe and environmentally friendly manner.

Waste Electrical and Electronic Equipment and Battery regulations (WEEE and Battery Directives)

Electrical and electronic equipment and batteries contain substances that can be harmful to the environment and to human health. The crossed-out wheeled bin symbol indicates that products should be disposed of in the appropriate recycling stream and not as regular waste.



Batteries

Remote contains CR2025 battery. Recycle or dispose of batteries properly.

Perchlorate material

Contains perchlorate material. Special handling may apply. See dtsc.ca.gov/hazardouswaste/perchlorate.

Mercury

The lamp in this product contains mercury and must be recycled or disposed in accordance with local, state, provincial and federal laws.



More information

See smarttech.com/compliance for more information.

Index

3

3.5 mm audio connectors 26

A

accessories

 included 4

 optional 5

alarms 61

aspect ratios 20, 60, 96-97, 99

audio

 connections for 26

 controlling volume of 28, 59

 muting 13

 resolving issues with 52

Audio menu 17

B

batteries 12, 105

Blu-ray players 102

C

composite video connections 61

connection diagrams

 ECP 28

 projector 25

contact person 62

D

DHCP 21, 62

diagnostic indicator, projector 45

display modes 13-16, 59

DNS 62

document cameras 101

drywall 8

dust v

DVD players 102

E

ECP

 about 4

 lights and status of 53

 using 27

electrostatic discharge v

email alerts 63

emergency alerts 61

emissions v

environmental requirements iv

eraser 5

F

fans 61

flickering 50

focus 24

H

HD signal compatibility 99

HDMI connections 26, 61

head space clearance 8

height 8

Help button 27

humidity iv

I

- image
 - adjusting 25
 - focusing 24
 - resolving issues with 49
- Image Adjustment 15
- ImageCare 19
- input selection 28, 61
- installation
 - choosing a height 8
 - choosing a location 7
 - securing 9
- interactive whiteboard
 - about 2
 - indicators and controls of 46
 - maintaining 31
 - replacing an older model 8
 - using 27
- IP address 21, 58, 62

L

- lamp module
 - cleaning 32
 - replacing 33
 - resolving issues with 48
- Language menu 23
- laptop computers
 - connecting 101
 - troubleshooting issues with 51
- letterboxing 96-97, 99
- light sources 7
- location 7, 62
- Low Power mode 28

M

- MAC support 96-97
- mercury 105
- mirror cover 32
- mounting template 8

mute control 13, 17, 59

N

- network communication 26, 53, 62
- Network menu 21

O

- options 5
- original packaging 55

P

- passwords 21, 54, 63-64
- pen tray
 - about 3
 - locking to the interactive whiteboard 9
- pens 4
- Perchlorate material 105
- peripheral sources 101
- pillarboxing 96-97, 99
- power 26, 28, 58, 69
- projector
 - about 3
 - adjusting settings for 14
 - adjusting the image of 25
 - cleaning 32
 - connection diagram for 25
 - diagnostic indicator 45
 - displaying the name of 62
 - error codes 45
 - focusing the image of 24
 - installing 7
 - lights and status of 42
 - locating the serial number on 43
 - remotely managing 57, 67
 - replacing lamp 33
 - routing cables from 9
 - securing to the boom 9
 - troubleshooting 48
 - using your remote control with 11
 - video format compatibility for 95

INDEX

projector status lights 45

Q

quad VGA support 96-97

R

RCA connector pod 5

RCA jacks 26, 29

refresh rates 96-97

remote control

about 4

code definitions for 103

installing the battery 12

using the buttons 13

RJ45 connector 26

room control 28, 57, 67

RS-232 serial interface 26, 68

S

SBX8-CTRL room control adapter 29

SD signal compatibility 99

serial interface See RS-232 serial interface

serial number 43

signal loss 49

SMART Board interactive

whiteboard See interactive

whiteboard

SMART U100 or U100w

projector See projector

SMTP 63

SNMP 65

sound See audio

startup screen 60

status lights, projector 45

subnet mask 21, 62

SVGA support 96-97

SXGA support 96-97

T

temperatures, operating and storage iv

transportation 55

TRAP destination address 63

troubleshooting 41

U

U100 or U100w projector See projector

USB drives 28

USB receptacles 26, 28

UXGA support 96-97

V

VGA connections 5, 26, 61

VGA support 96-97

video

connections for 26

format compatibility for 95

volume control 28

W

warnings iii

water and fluid resistance iv

web page management 57

WEEE and Battery Directives 105

whiteboard See interactive whiteboard

X

XGA support 96-97

Z

zoom 60

SMART TECHNOLOGIES

smarttech.com/support

smarttech.com/contactsupport

smarttech.com/kb/170911